

שם _____

כיתה _____

מתמטיקה – "משחקים את המשחק"

דף שבועי

חטיבת ביניים

ספר 1

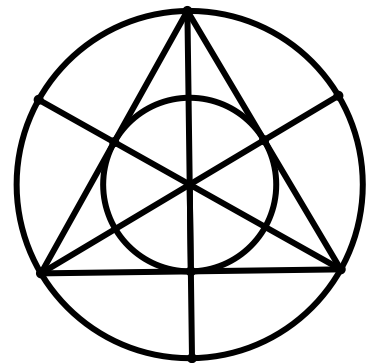
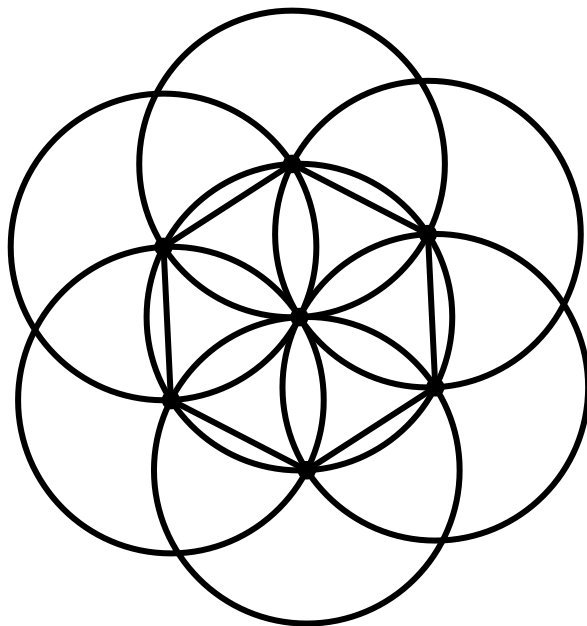
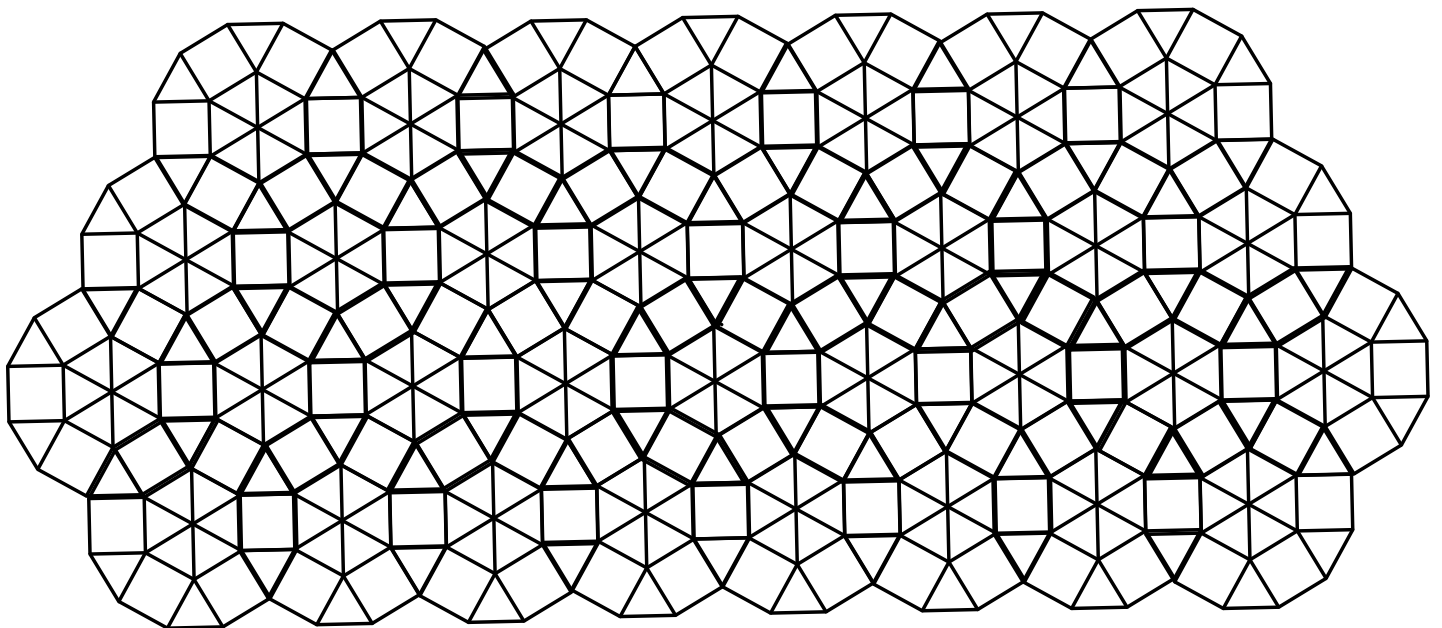

חומר הספר מ-

The New York Times

Conceptis Puzzles

Star Battle

Games Magazine

Erich Friedman

Hidato

Set

Area Mazes

Strimko

Nrich

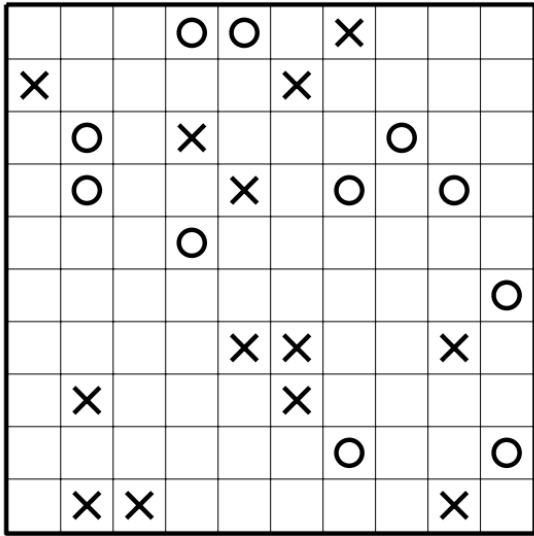

© Conceptis Puzzles 31090100974

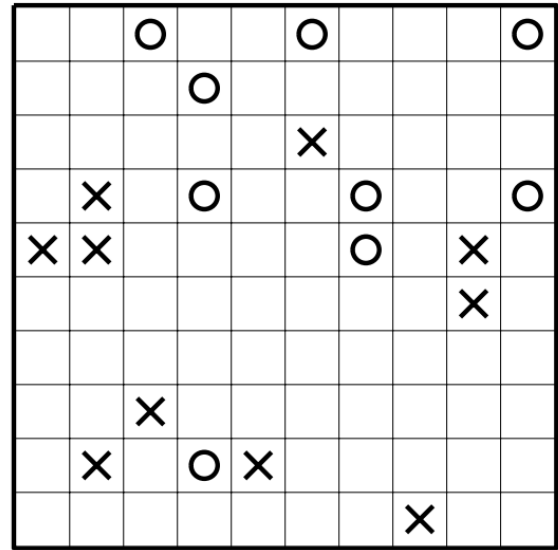

© Conceptis Puzzles 31090101387

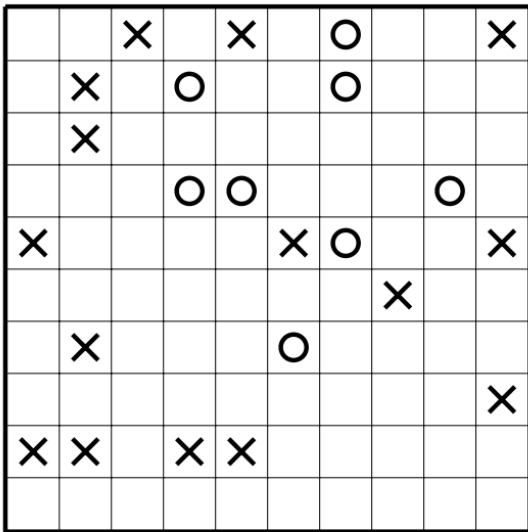

© Conceptis Puzzles 31090102017

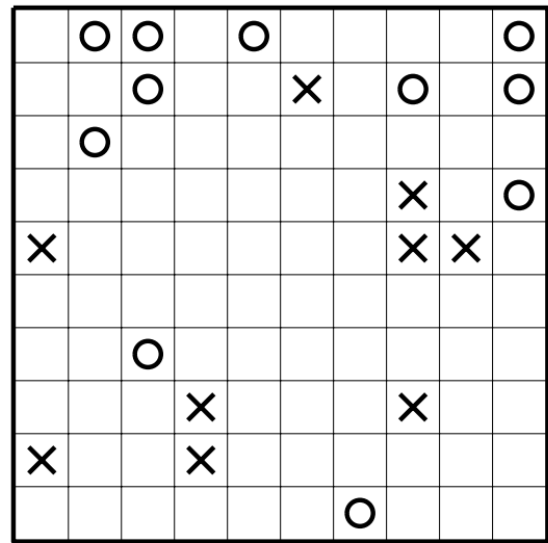

© Conceptis Puzzles 31090104703

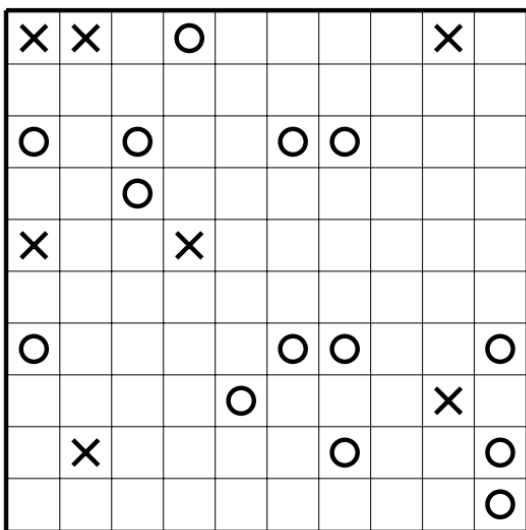

© Conceptis Puzzles 31090104763

44

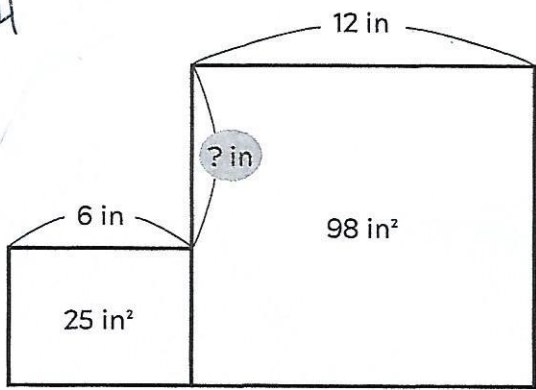

45

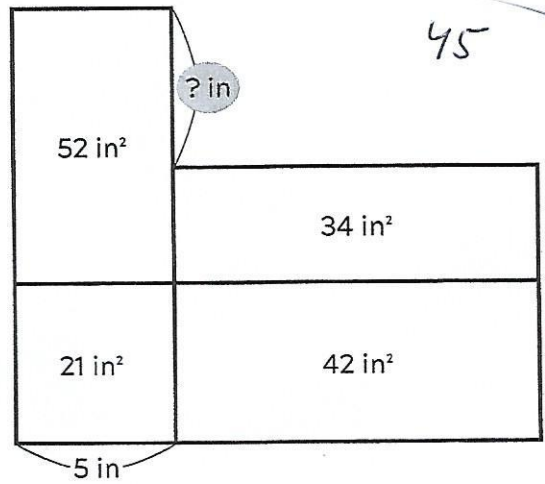

46

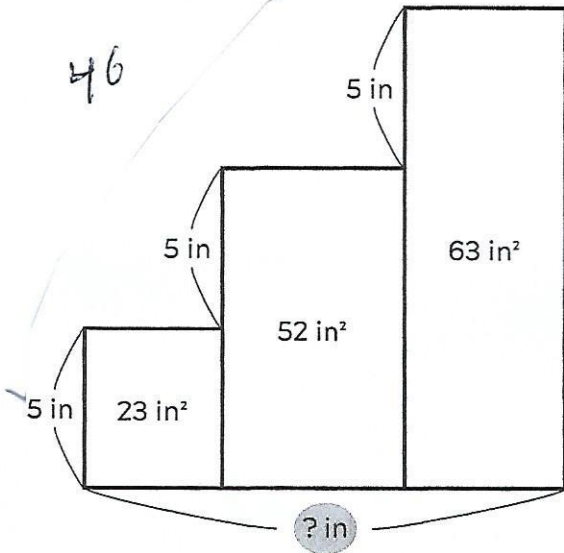

47

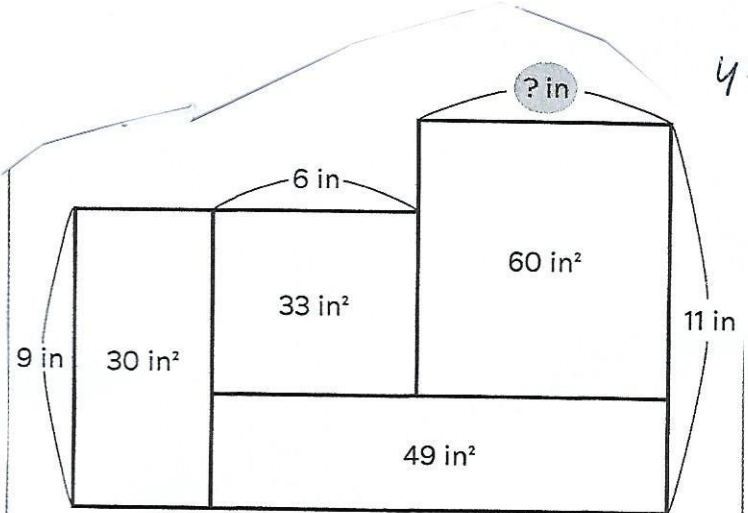

48

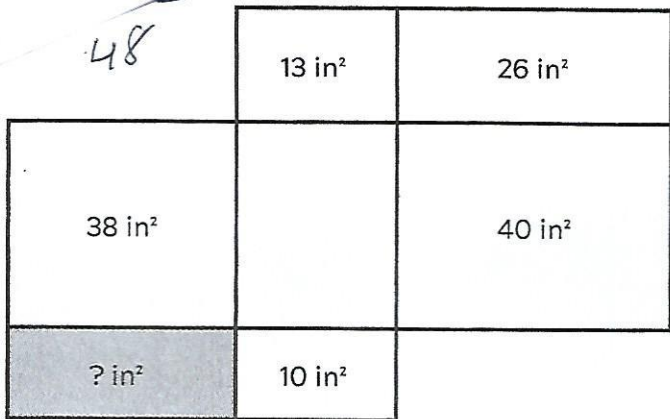

49

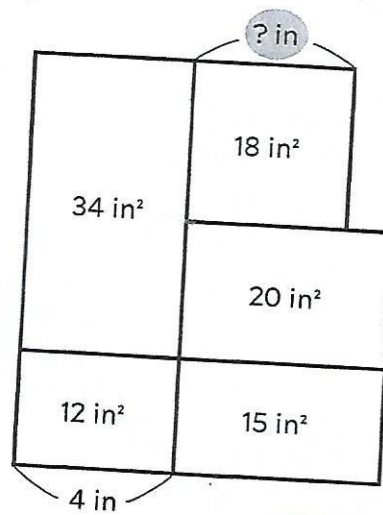

50

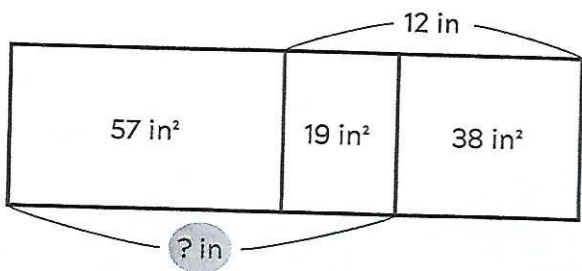

51

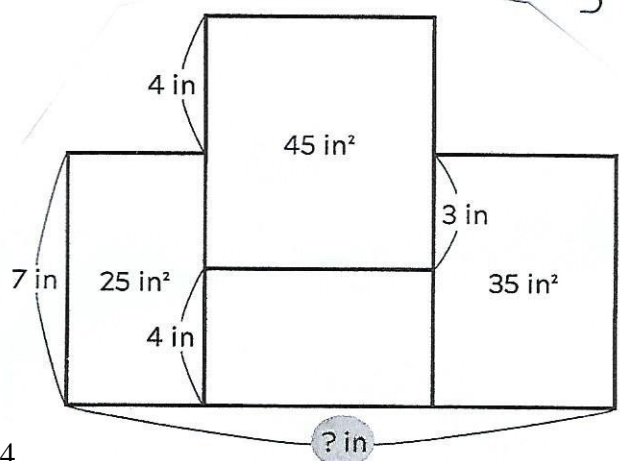

- 975 - P
- 246 - FP
- 267 - PP
- 526 - P
-
- 123 - F
- 456 - P
- 789 - F
- 185 - FP
- 148 - P
-

5+	24x		
		2÷	
8x			3
1-		3-	

www.kenkenpuzzle.com

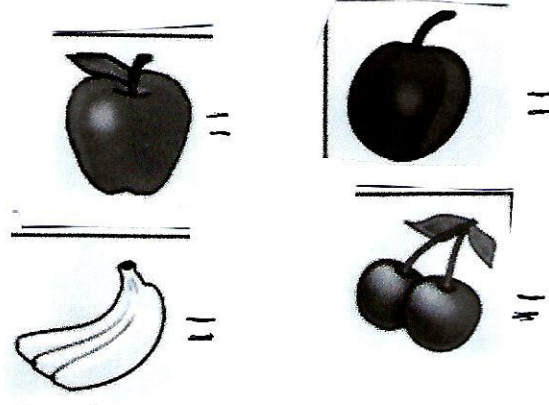

Fבדיוק
Pכמעט
Bכלום

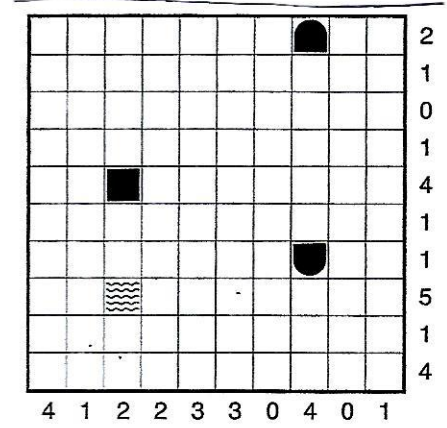

- Battleship
- Cruisers
- Destroyers
- Submarines

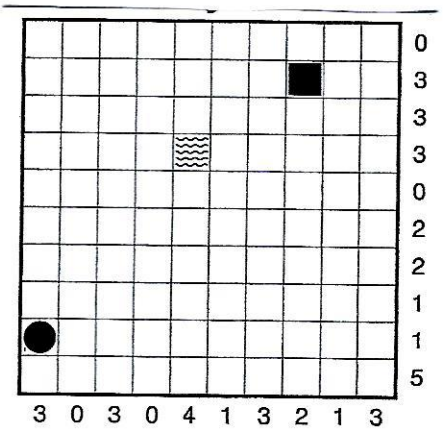

- Battleship
- Cruisers
- Destroyers
- Submarines

				(33)
				(30)
				(45)
				(42)
(43)	(41)	(33)	(33)	

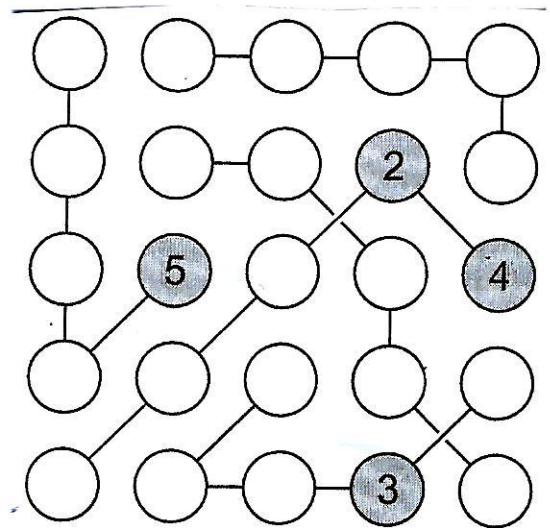

123- PP
 456 - B
 789 - P
 172 - PP
 837 - FP

בדיוק
 כמעט
 כלום

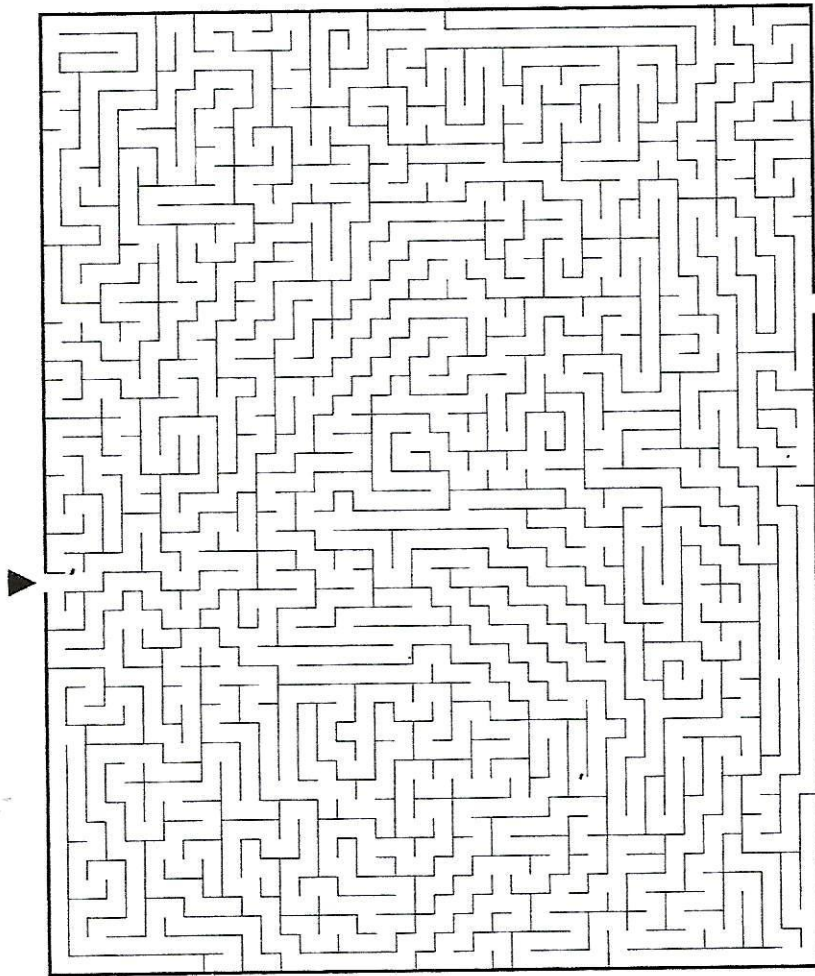

123-P
 456- P
 789- B
 364- PP

בדיוק
 כמעט
 כלום

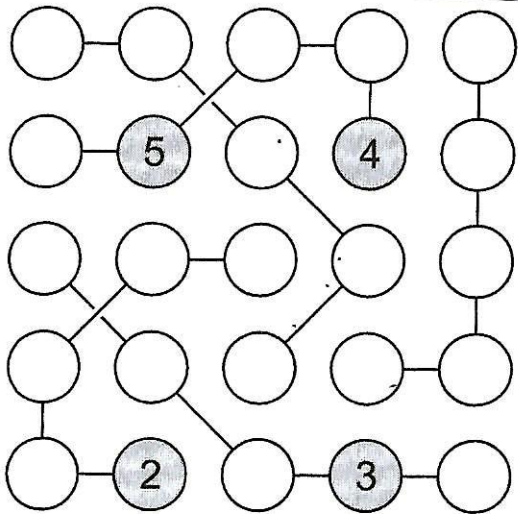

1-	2-		2÷
	5+		
24x			3
		3-	

www.kenkenpuzzle.com

3-ENSIGN

Battleship
 Cruisers
 Destroyers
 Submarines

2-PETTY OFFICER

Battleship
 Cruisers
 Destroyers
 Submarines

יש 4 מוקשים. מצאו עוד 4 מוקשים.

1		2	*		0
1		3		2	
	2	*		1	
1	3		3		2
2	*	*			1
	3		2		1

1	*	3			1
	1		*	3	1
1		2		1	0
	*	1		1	
2		3			1
1		2	*		1

					17
3			8		
		12			
1		31			
		26			21
	36				

	8			13	
		4			
23				1	
				18	
		27			
36				32	

80. משולשים וריבועים

איזה חלק משטח הריבוע צבוע בשחור ?

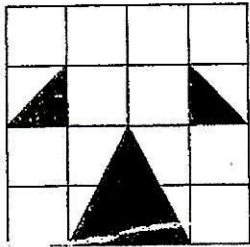

78. התחלקות ב-9
נתון מספר 321321321321. איזה ספרות יש למחוק כדי לקבל מספר גדול ככל האפשר שמתחלק ב-9?

מצאו את סכום שש הזוויות.

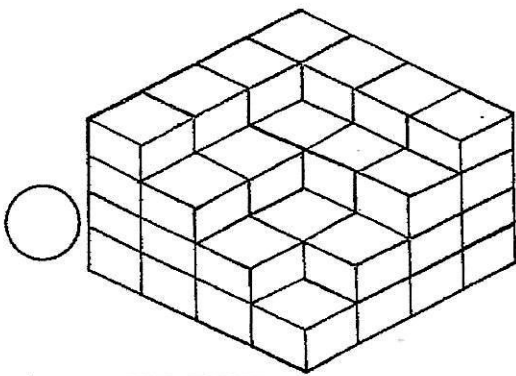
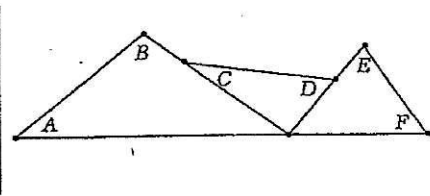

כמה קוביות יש? (9003#)

123 - F
456 - P
789 - F
169 - FP

בדיוק
F
כמעט
P

PUZZLE 1

X				X			
			O				
O	O			O			X
	O			X			O
				X		X	
							O
	O				O	X	
						X	
	O	O			O		
		X		O	X		

123 - PP
456 - B
798 - F
712 - PP

בדיוק
כמעט
כלום

1-SEAMAN

	●	●									

1 1 3 1 4 0 6 0 4 0

BATTLESHIP: [4 squares in a row]
CRUISERS: [3 squares in a row] [3 squares in a row]
DESTROYERS: [2 squares in a row] [2 squares in a row] [2 squares in a row]
SUBMARINES: ● ● ● ●

	6				
				30	
	12				
	1			36	
					24
18					

PUZZLE 1

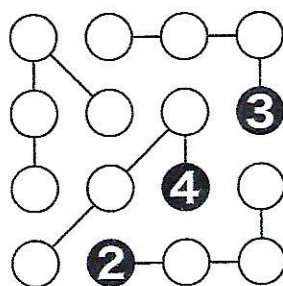

PUZZLE 2

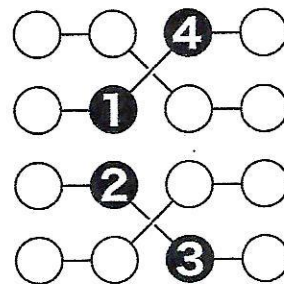

PUZZLE 3

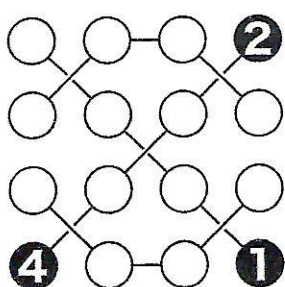

PUZZLE 4

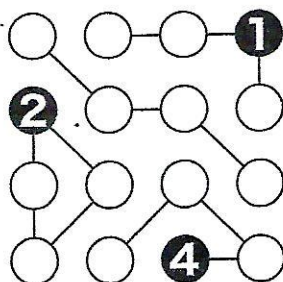

PUZZLE 5

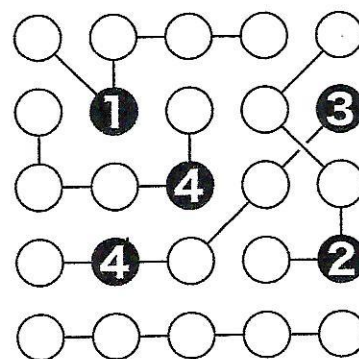

790 - P
 123 - F
 456 - P
 789 - F
 185 - B

פדיוק
 פכמעט
 בלול

1-SEAMAN

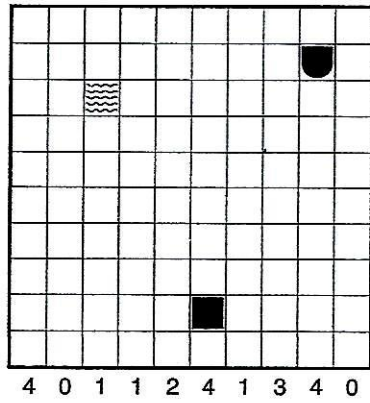

2-PETTY OFFICER

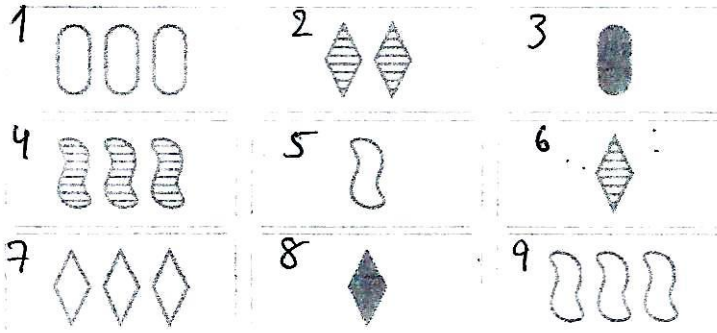
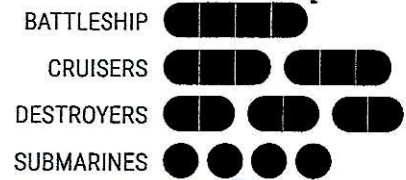
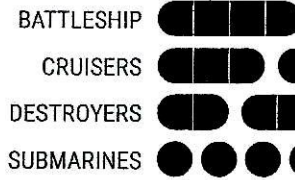
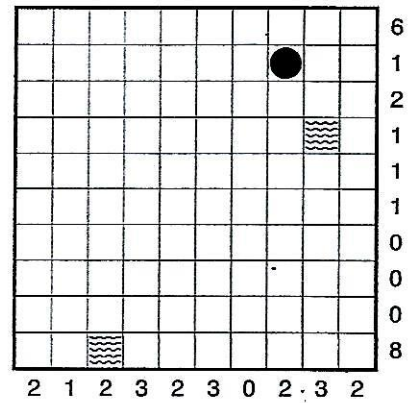

8x			3
12x	1-	7+	
		2-	2÷

www.kenkenpuzzle.com

PUZZLE 1

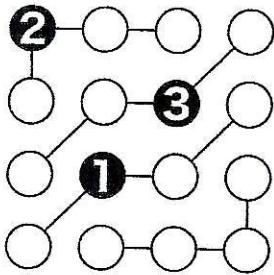

PUZZLE 2

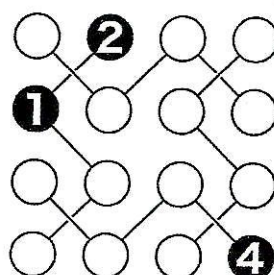

PUZZLE 3

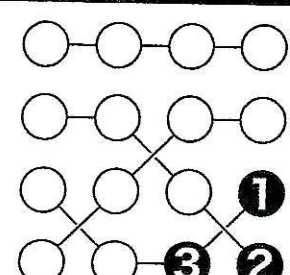

PUZZLE 4

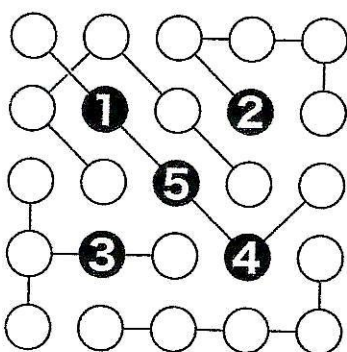

PUZZLE 5

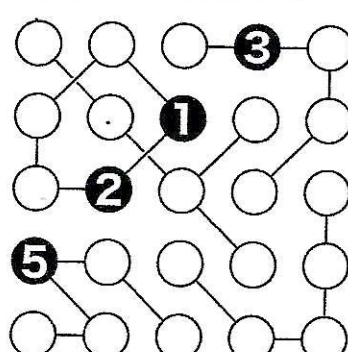

PUZZLE 6

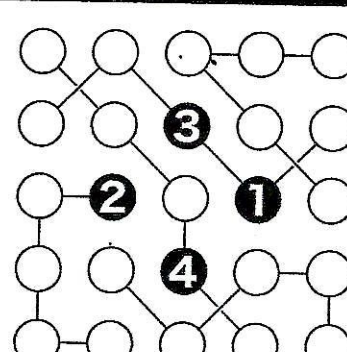

2004

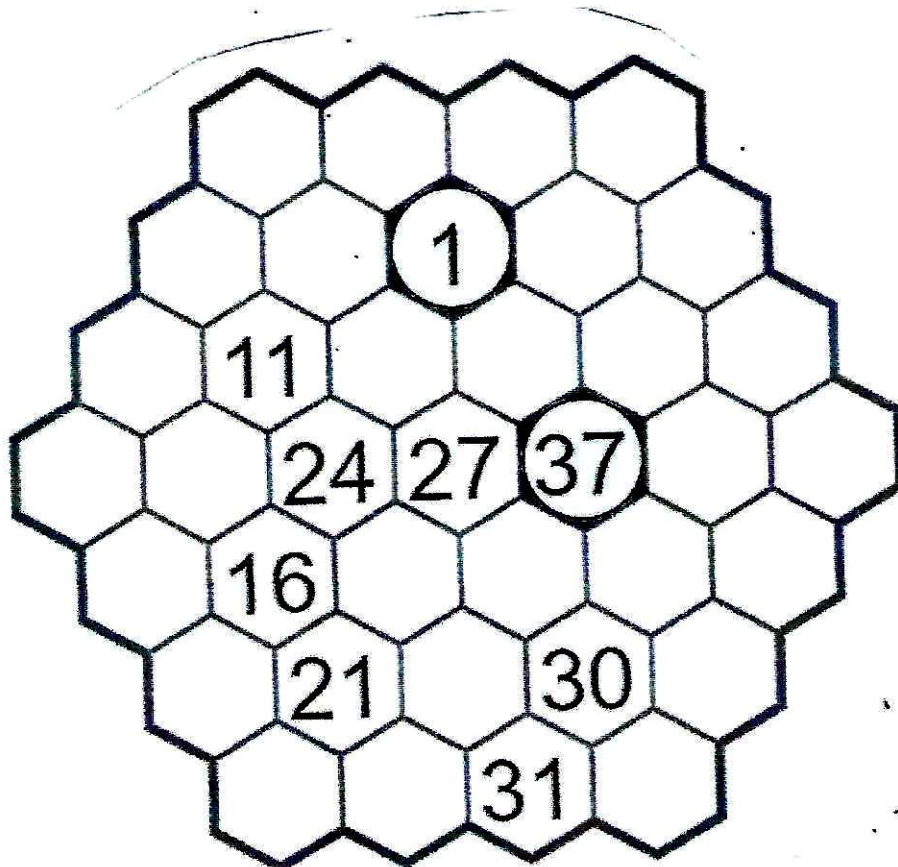
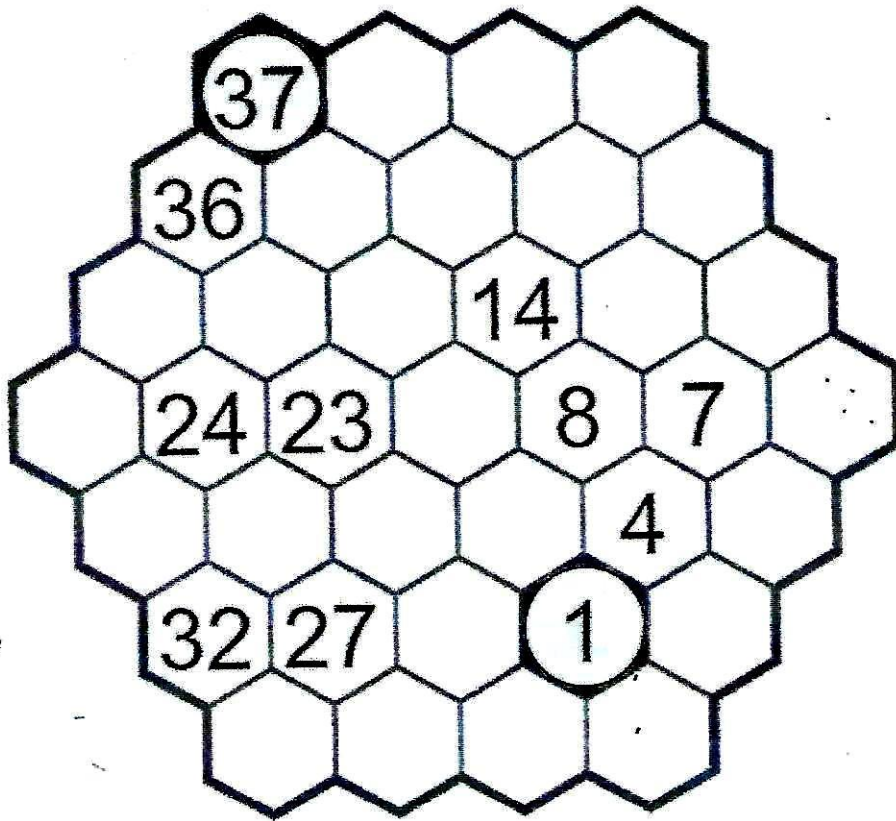

803 - P

123 - F

456 - B

789 - FP

197 - P

פבדיוק F

כמעט P

כלום B

123 - P

456 - P

624 - F

789 - B

341 - F

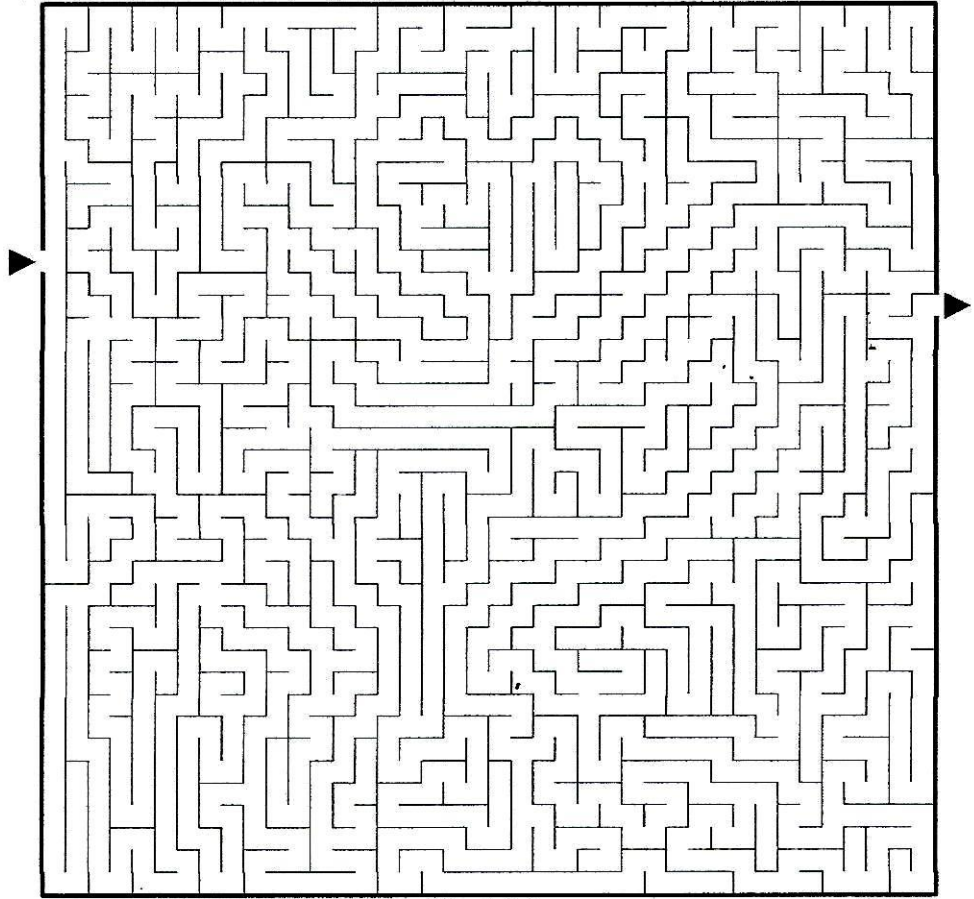

© Conceptis Puzzles

04090100426

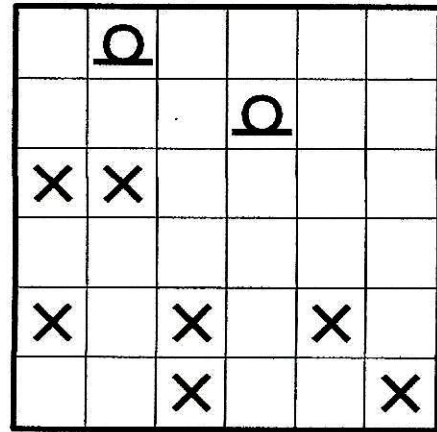
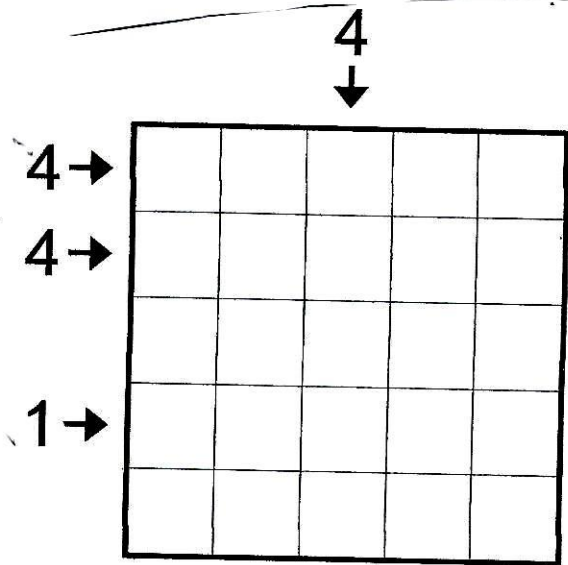

© Conceptis Puzzles 31090103332

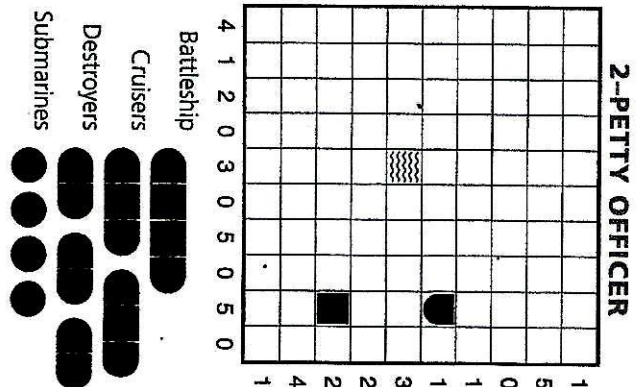
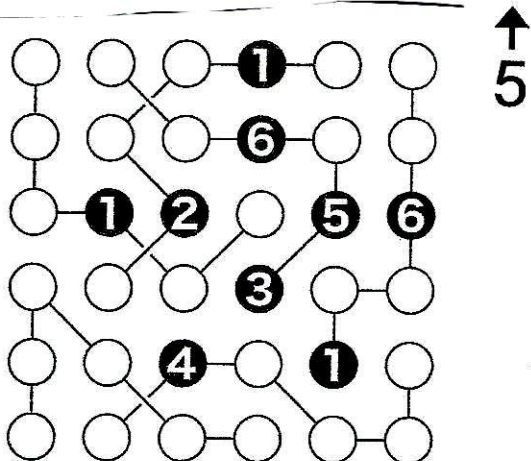

975 - B
 864 - F
 321 - FP
 823 - F

בדיוק
 כמעט
 כלום

178 - FP
 234 - P
 893 - PP
 386 - PF

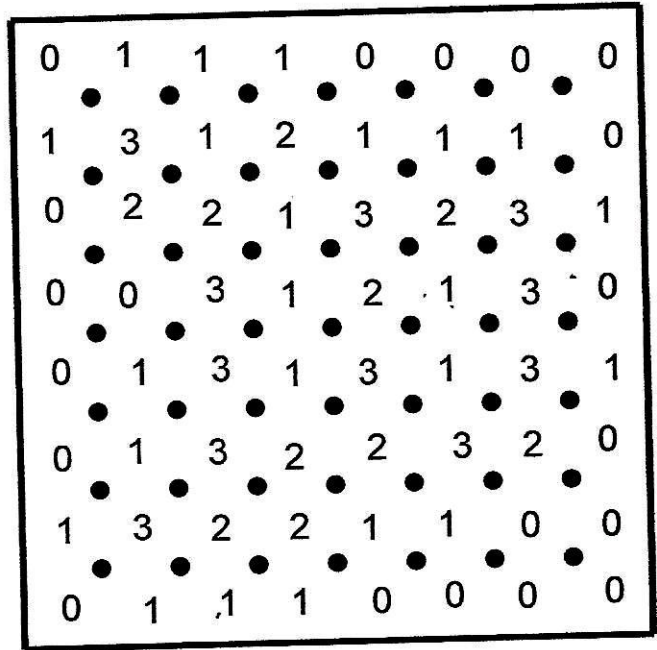

3-	2÷		12x
	5+	1-	
5+			1-
	3-		

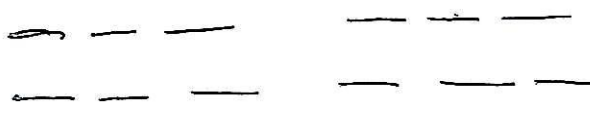
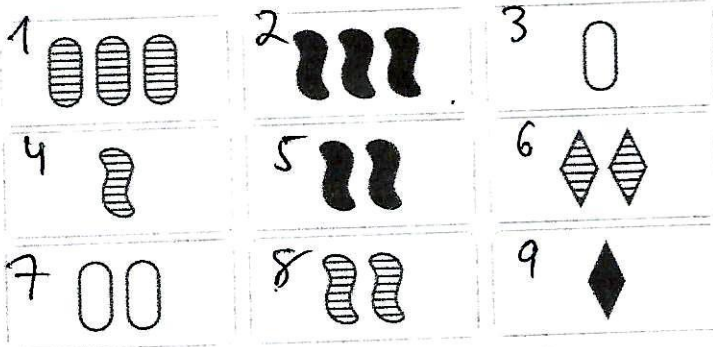
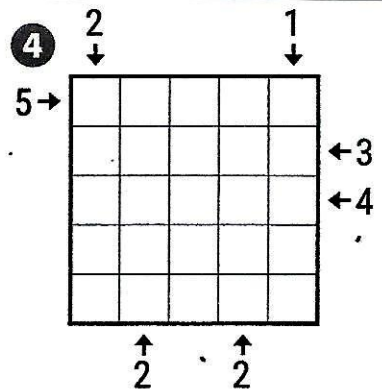
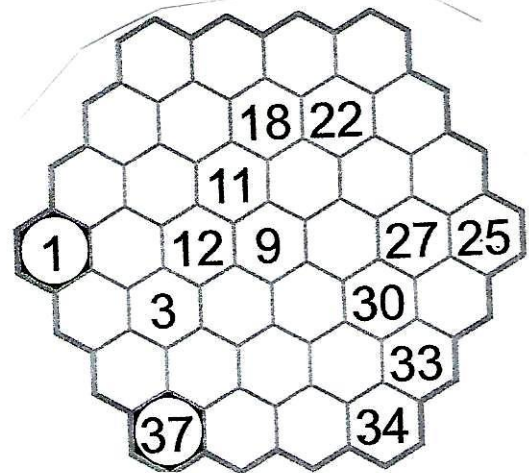

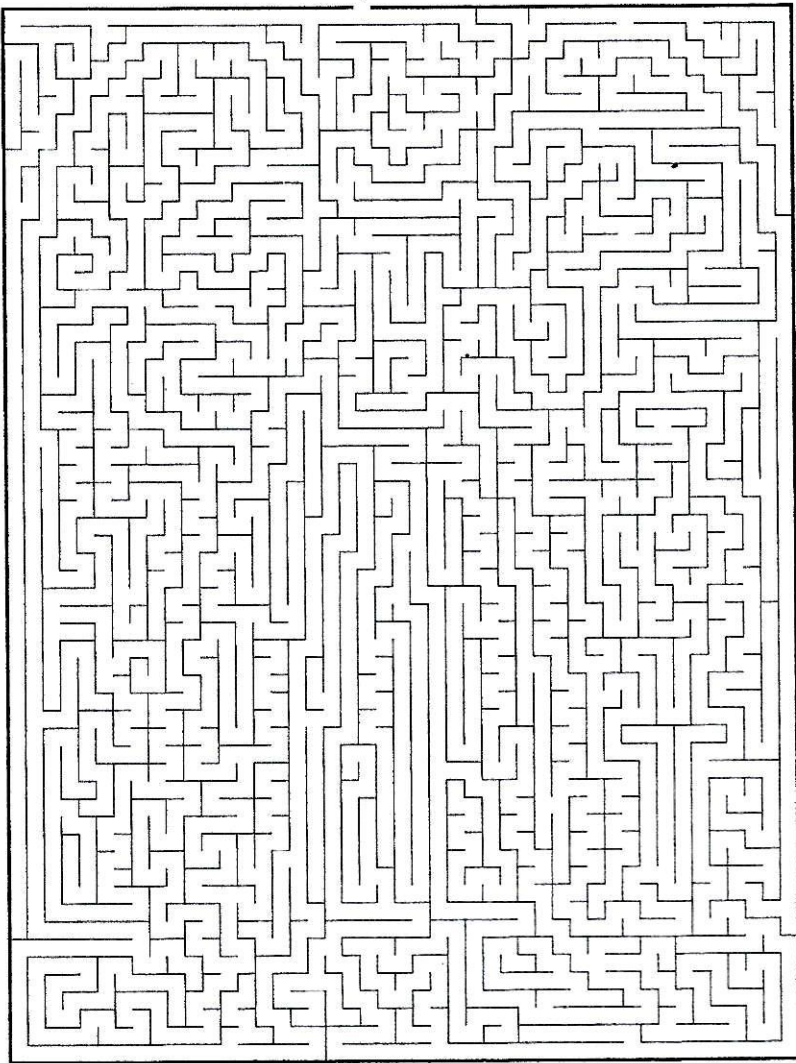

3-Ensign

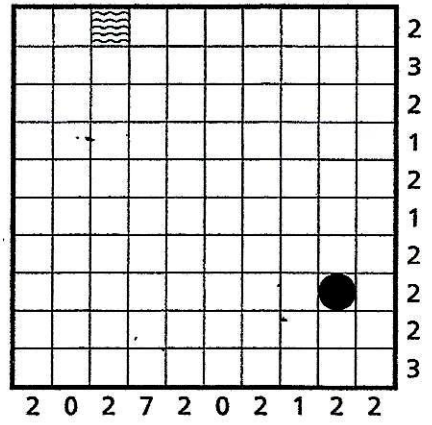

- Battleship
- Cruisers
- Destroyers
- Submarines

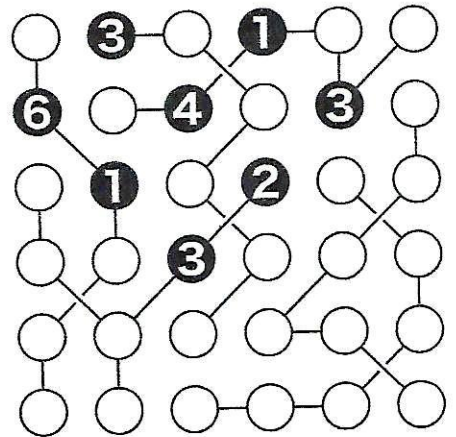

X								X		
			Q	Q						Q
	X		P			Q				Q
Q		Q								
			X							
	P									
			Q				X	X		
Q					X			X		

© Concentis Puzzles 31090103354

[8x12]

12

A				
	B			
			C	
B	C		B	
				C
A	B			

1771

- 123 – PP
- 456 – P
- 362 – F
- 541 – PP

בדיוק
כמעט

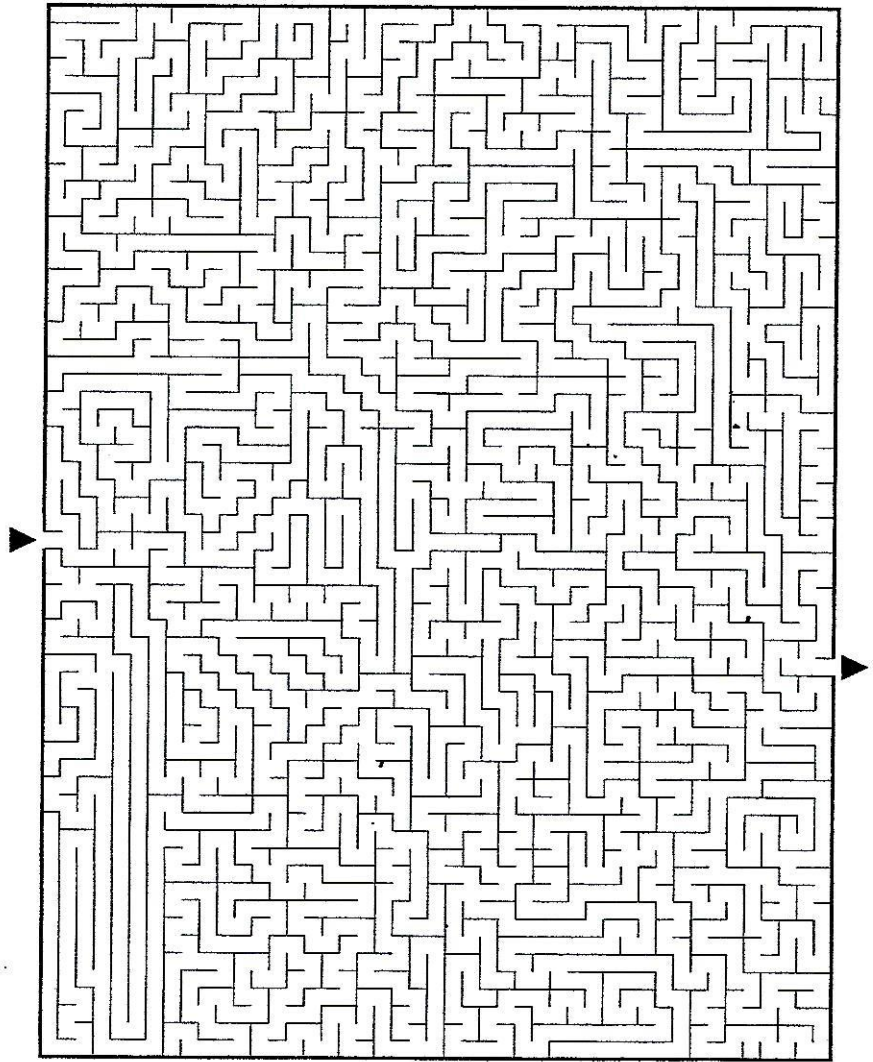
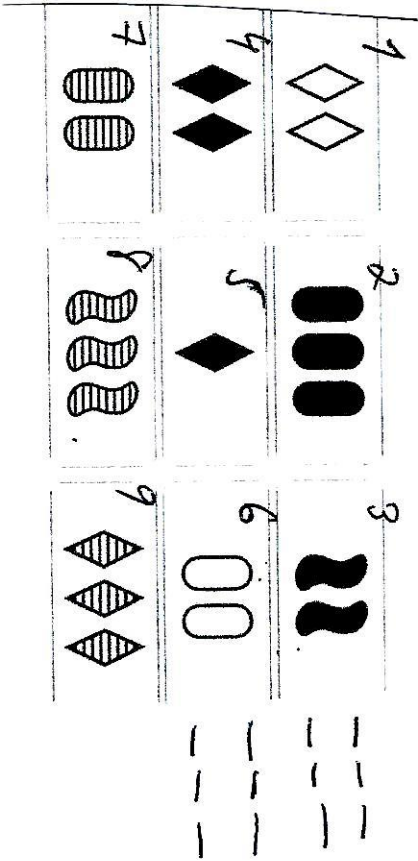

6x	7+		8x
	2-	2÷	
8x			
		1-	

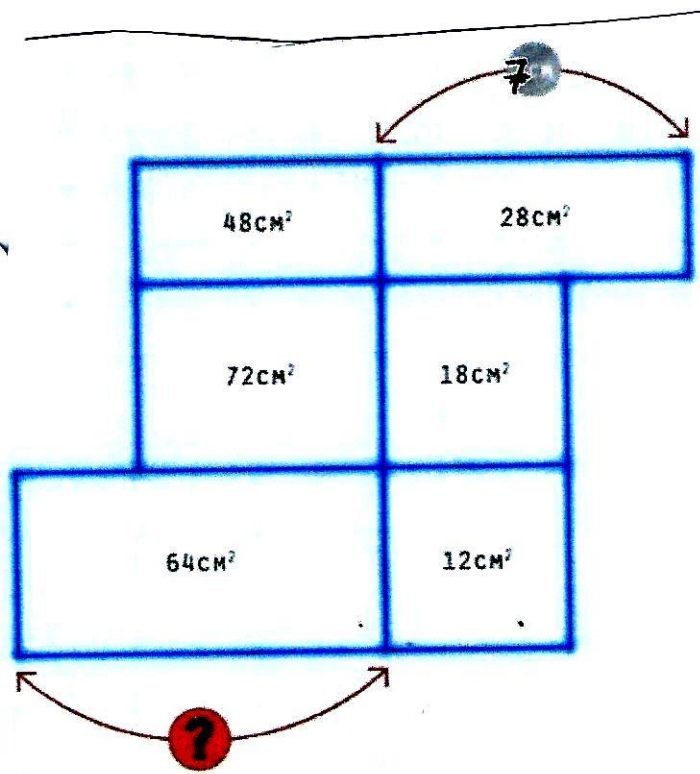

Maze #66

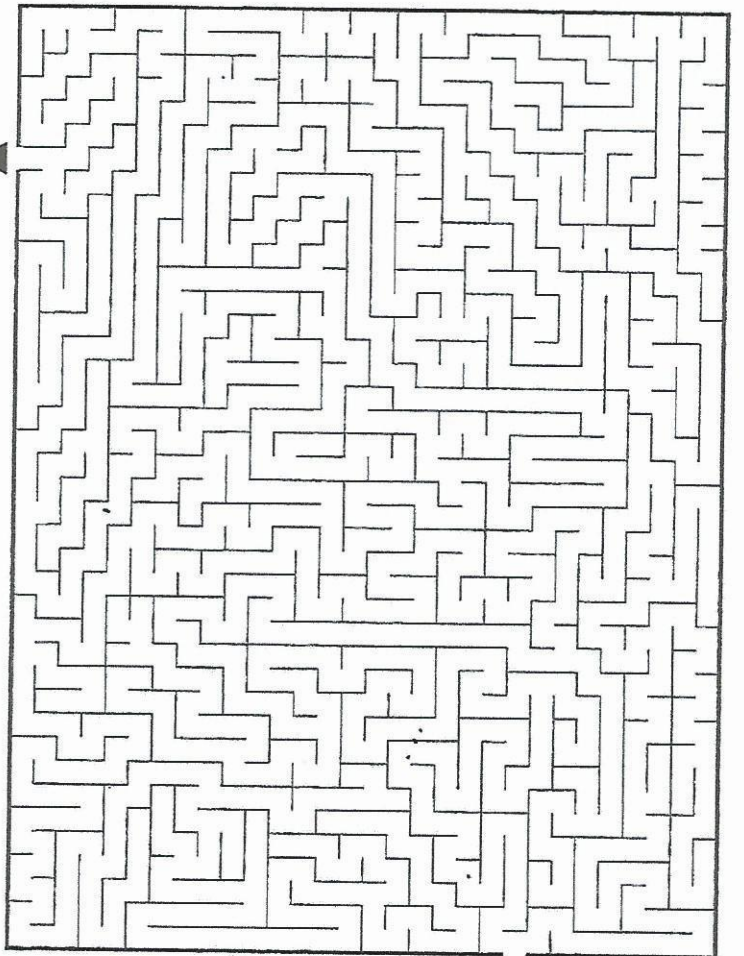
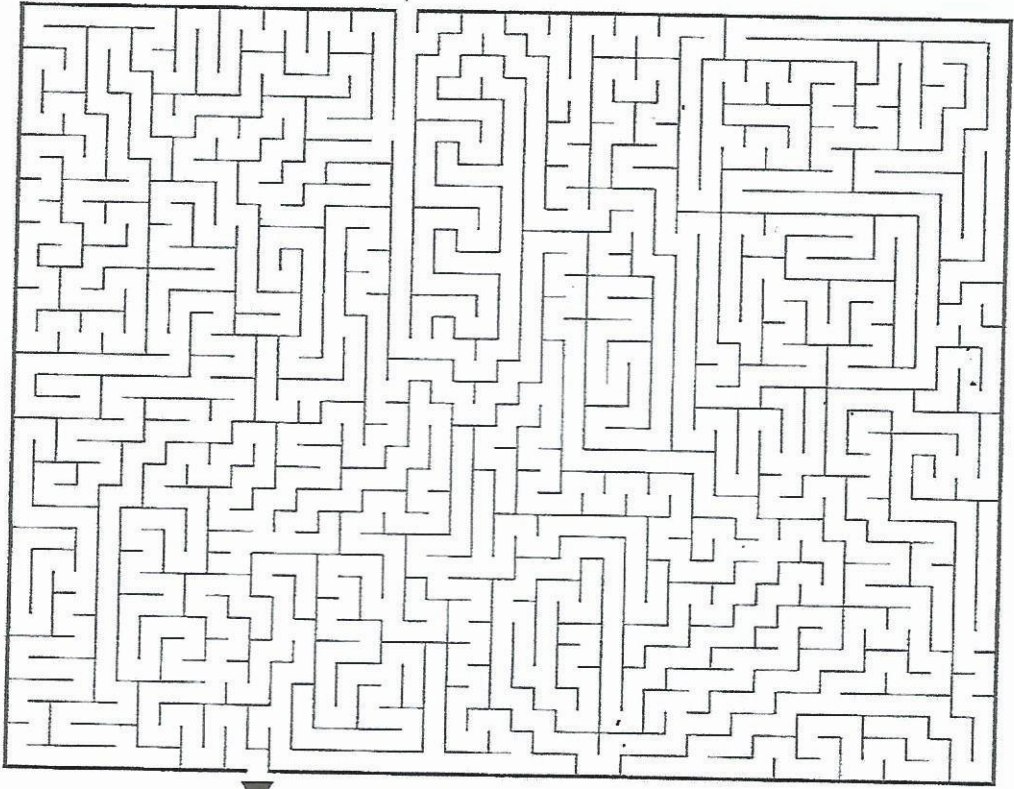

2-Petty Officer

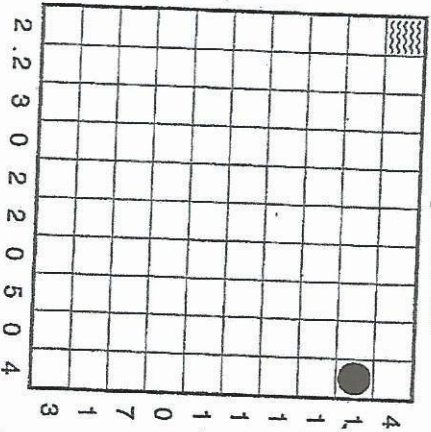

- Battleship
- Cruisers
- Destroyers
- Submarines

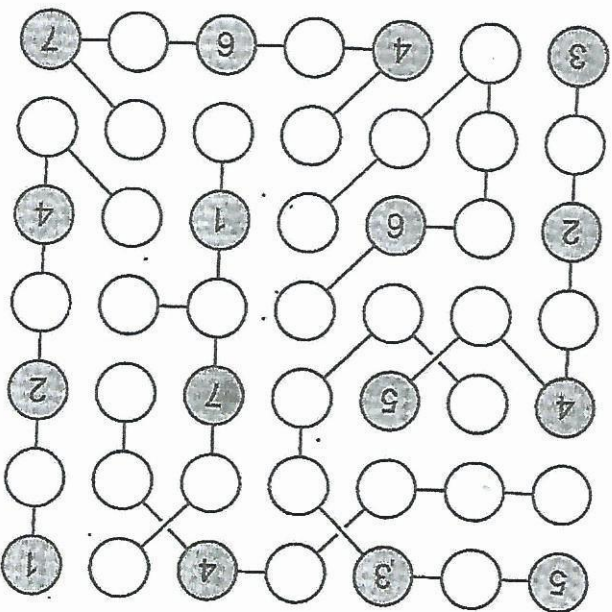

- 859 - PP
- 123 - F
- 456 - P
- 789 - P
- 175 - F
- 943 - F

פבדיוק
 פכמעט
 פכלום

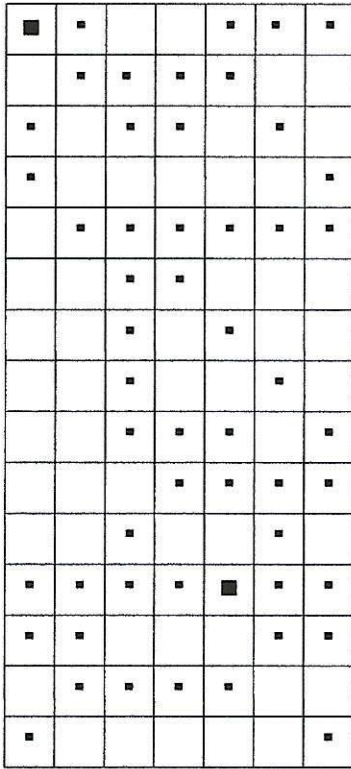

		4	2	2			6		4	8			8		
7				3	8			8	4	3		8	4	4	
	10			3	4	4		6	3			4			
		4			1			1				4			
10	4									1				6	
4	4	4	2	2					3	3				1	
	7									4		4			
				2	2	2			2	2			3	6	
6		1	3	2		3		1		3	3	3		1	
6	4			3	3			2	3				1	3	
4			3		3	2			3		2	2		9	
	9	6		6	3	1		1	3	1		3		2	2
6		4	4	1								2	3		2
										2	3		2	4	2
	3	7				7				1	2			9	4
6		3					1			1					
9	10		2	1		1	2		2	9	5				
			2			2	2				9				3
3		3					1		3		5	2		2	
			10			3		3	3			2		2	
												2			3

(C) Conceptis Puzzles

2006015

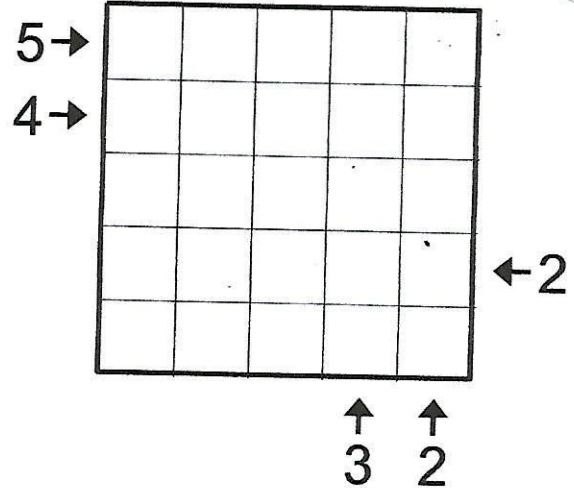
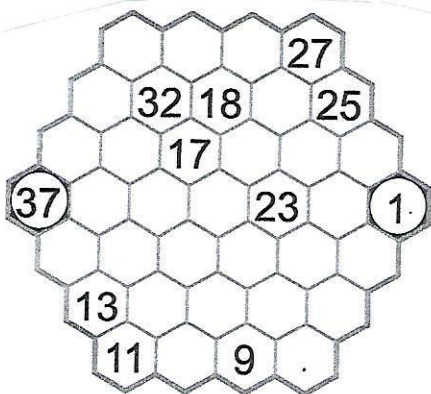
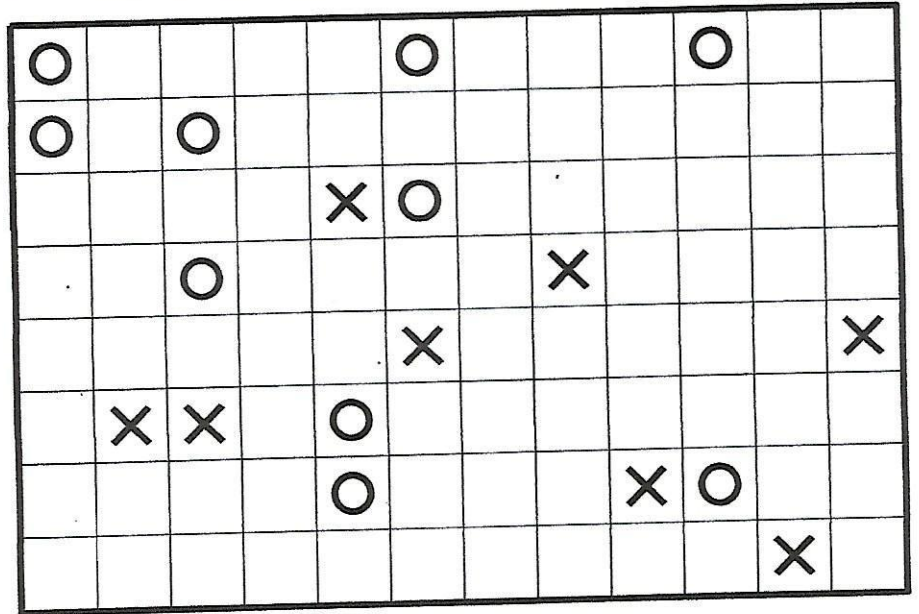

. 2014

2016

2-Petty Officer

- 123 - P
- 456 - P
- 789 - F
- 681 - P
- 249 - F
- 461 - P

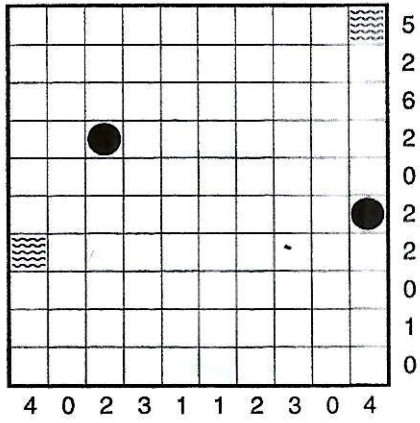

- Battleship
- Cruisers
- Destroyers
- Submarines

בדיוק

כמעט

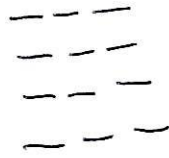
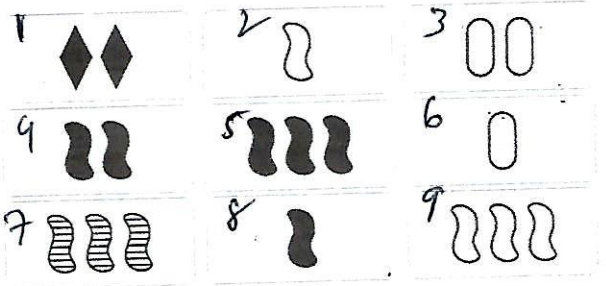

3-Ensign

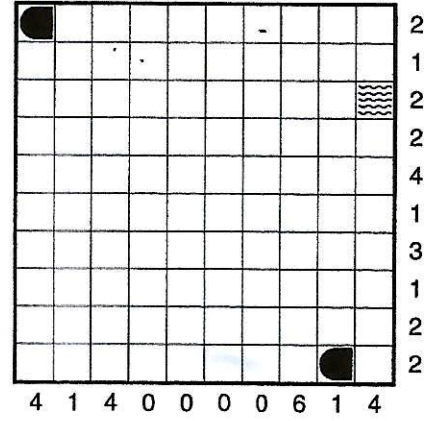

- Battleship
- Cruisers
- Destroyers
- Submarines

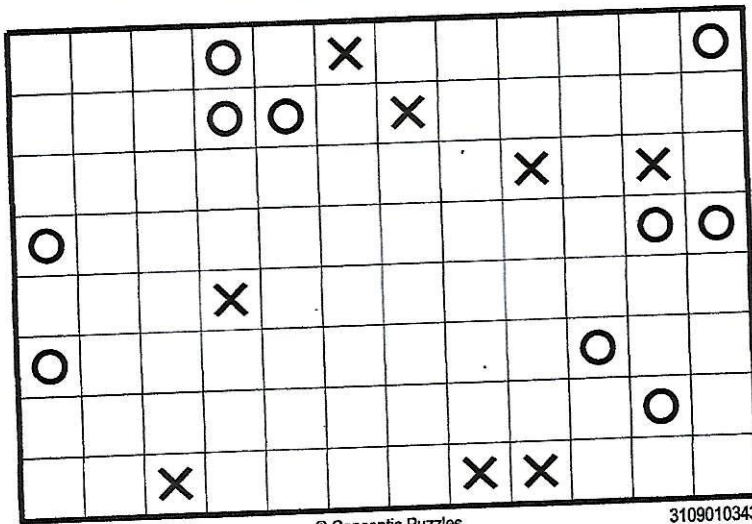

© Conceptis Puzzles

31090103434

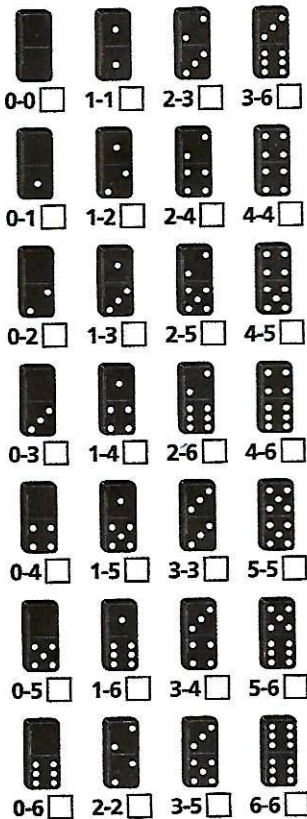

02 12 01 01 00 01 03
45 36 13 24 12 23 45

0000115
0233456
0112345
4555666
0122224
2234456
0133346
1134566

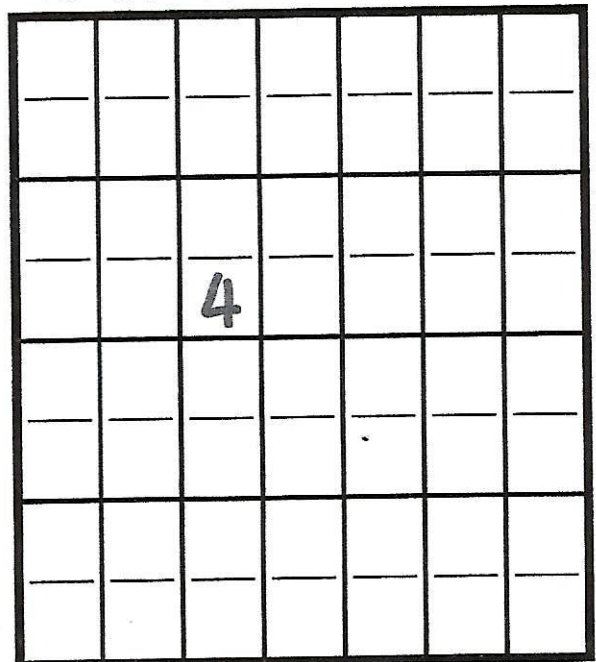

04 33 45 13 14 22 24
56 56 66 45 66 35 56

11			2 1			8				8 5		12			
7	7		2			1				5				7	
4	4	7			4 4 1				3	3				7	7
7			2 2				5		5		7				
		3	2 2		4	3	3	8						11 7	
		2			2 4			2 2		7					
7	3	9		2 2		8				7 12		8			
11	1			2	3	3	4 3	3					11	10	
3 7			10	1			4						8		
	3	9		6		6	7					4			
3			1		5		5	13 3	6			4			
5 3 5					5 6				6 2 2						
	10 9		2	5			4 6 3		13			10			
		8	1	2		7		4				3	3		
	3	3		8		10 6	7		1 2					1	
			6	6			3	1	2 2						
7 8		9									2				
		8	6	6		3									
1	1	5	3	3		6									
4		1	5			5 10				2					
3		7	5	4		4	1			2 1					
4			2				6 6				3	3			
3	2	14		2 14	2 2		6				5	2			
1	2		4 4		1	6		4		4 5		2			

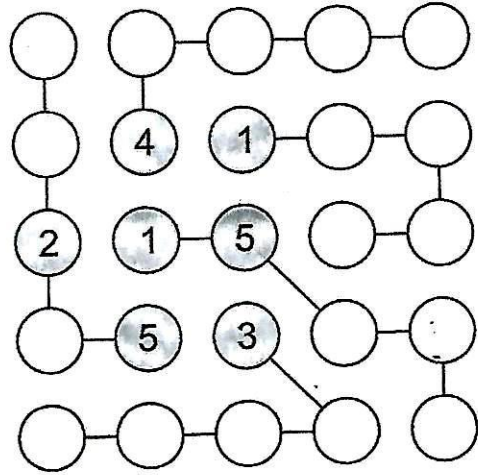

6x		11+	
2-			
	2÷	1-	4+
4			

www.kenkenpuzzle.com

1-9

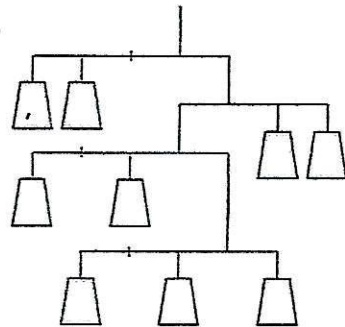

18			1		
				12	
	24				6
36					
					30

	■	■	■	■	■	■
■	■	■	■	■	■	
	■		■	■		■
	■	■		■		■
	■	■	■	■	■	■
		■	■	■		
			■	■	■	■
	■	■		■		■
			■	■		■
	■	■		■		■
	■		■	■	■	
■	■		■			

- 987 - P
- 546 - B
- 321 - FF
- 821 - F
- 329 - FP
-
- בדיקה
- כמעט
- כלום

55186

506 – PP
 123 – F
 456 – PP
 165 – FP
 543 – P

— — —
 בדיוקן
 כמעט

0	1	1	1	1	1	1	1	1	0
1	3	2	2	1	1	2	2	3	1
0	1	2	2	2	1	3	2	2	0
0	2	3	1	2	2	1	2	3	1
1	2	1	2	1	3	2	3	2	0
1	1	1	1	2	1	1	1	3	1
1	2	3	2	3	3	3	2	3	0
1	3	2	3	1	1	1	2	3	1
0	1	0	1	0	0	0	1	1	0

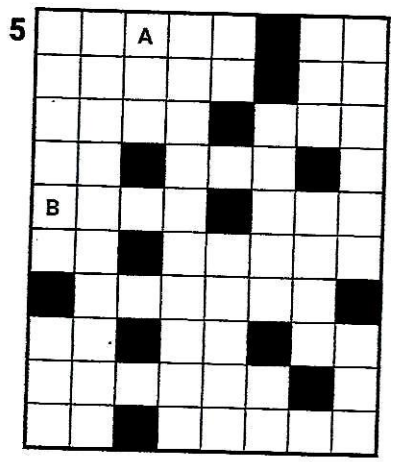
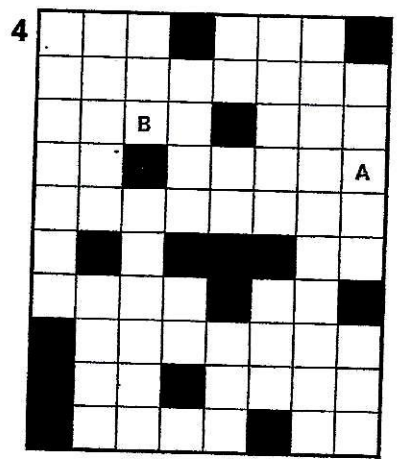
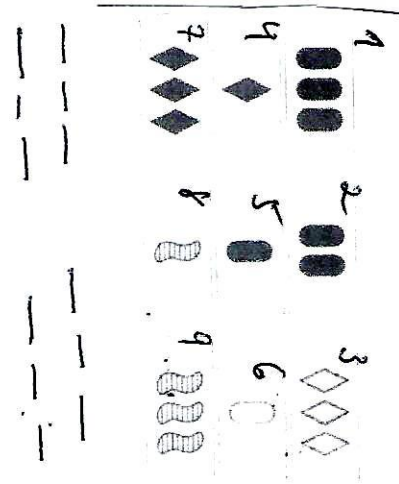

3-Ensign

Battleship
 Cruisers
 Destroyers
 Submarines

PUZZLE 4

PUZZLE 5

PUZZLE 6

2020

4	9					9			1	2	3			8	8
		5	5			2		2	2					9	
4			3	5		2		2		3				8	
3				3										6	
	2		8			3		3	3						
3	2	5	3		1						8				9
4		8	3					3		8			8	6	2
	2		3			2	2		1						2
	2		3			2	2			6	6			2	
4	2		3	8		1				4				2	2
4				5						3	4				2
	7	2				3			1			1			
	1		2			1				3	2				5
4						3					2				1
10			7	8				1					1		
2	1	2	2					2	2					5	2
2		6		6	1					1	2				2
	3		1			5				5	2	4		4	
3	10			1	1		3	3		1		4		4	
	3	3	3	1	1			1	1						

(C) Conceptis Puzzles 2006010

4			4										5		2
		4		3									5		2
4	4		1		4	4	8	7	4		3				
				3		4								4	4
4	5		2			4		4		8	3	2			2
	4	2						7		5	2				2
	5		1		1	5					8	3			
4											3				
2	2					3				8	4	4			
4		4			4					2					
		2				3		1		2	4				3
		2	2	3	2	2				4					
4		2		3					3		3		1	3	
	3							2			4				
3	2	2						1	2	5				5	4

(C) Conceptis Puzzles 2006005

9	9			9	1			8	1			5			
		4		8		1				5		5			
9	1	5		2		5			4	2	2				
						1			2	2		5			
		4								4		5			
		5		2	2				2	2		5			
		4		4	4	4	4	1	4	4		5			
4	3	1	3					1							
		5	1	5	6	4	4	6	4	2					
2	2							4	1	4	2			5	4
				2		2		2	2					4	1
														1	
		4	4	6						3	1			3	1
7		7								3	1			1	2
				4	4					3	6			3	6
				6	6			6						6	2

(C) Conceptis Puzzles 2006006

			9			9	8			5					
	6			3			5		9						
	6		3			8				9					
1				3		3		2	2					6	
		2	1						1					3	
		2									4				
1				1				1		4				3	
2	2				3		2							6	
		7					2		2	4					
	7	2	2			3	1		3	2	4				
									1	3					
1									1						1
					1			2						4	
			1			2	2	2	2					9	
			1					2		5				4	
				4				4		6					
		2	2					1		7	5				
4				2				1			7				
	4			4	2		1		5					9	
	4					5			6	4				4	

(C) Conceptis Puzzles 2006008

3-ENSIGN

- 957 - P
- 846 - F
- 321 - P
- 892 - P
- 245 - F
- 276 - B

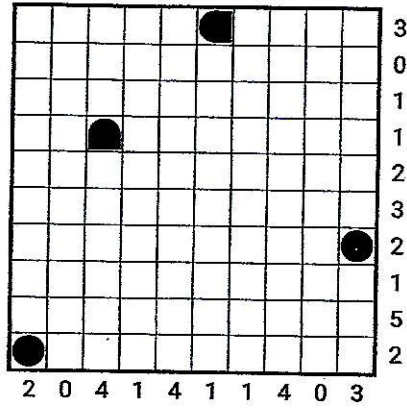

 בדיוק **BATTLESHIP**
 כמעט **CRUISERS**
 כלום **DESTROYERS**
SUBMARINES

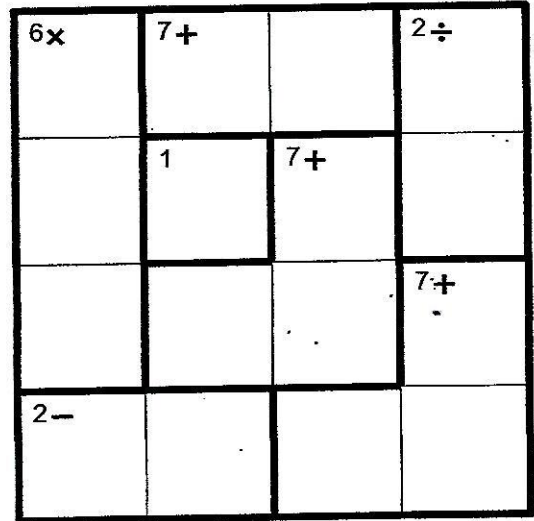

www.kenkenpuzzle.com

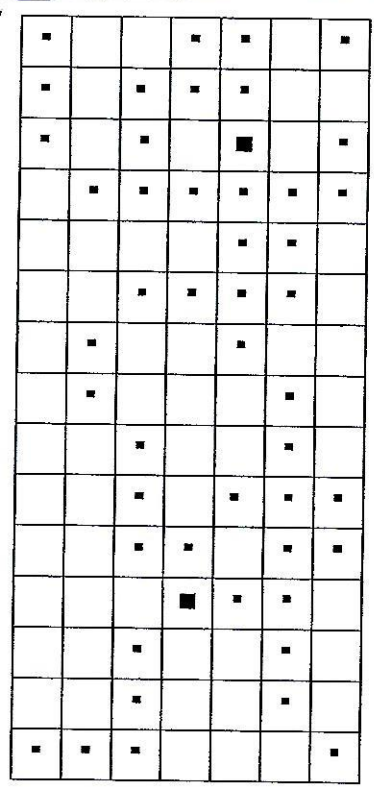
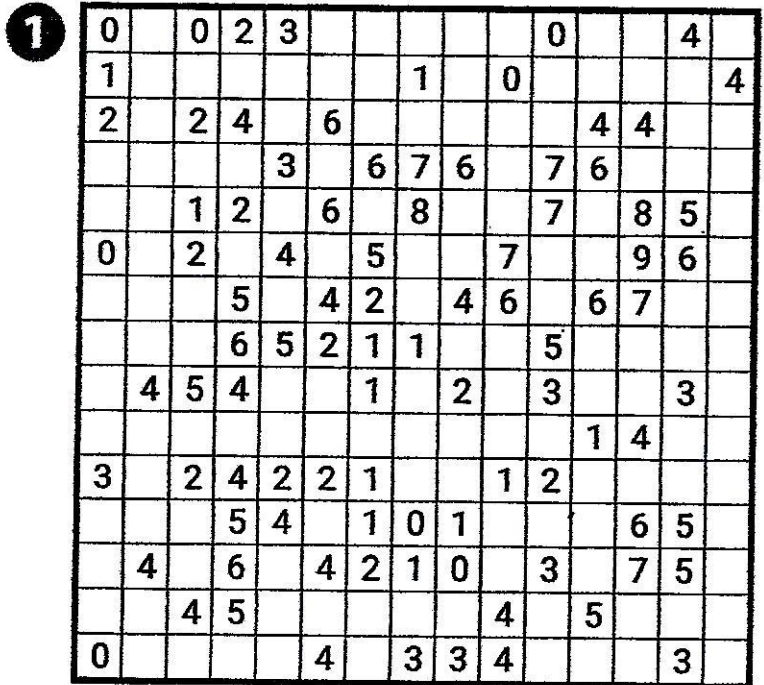

כל מספר במשבצת מסמן כמה משבצות
 מסביב לאותה המשבצת (כולל באלכסון)
 יש להשחיר כולל המשבצת עצמה.

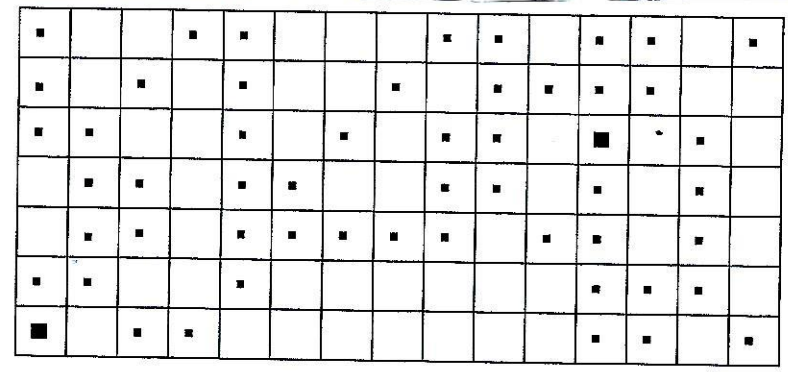

2022

- 395 - F
- 467 - B
- 890 - F
- 192 - P
- 258 - PPP

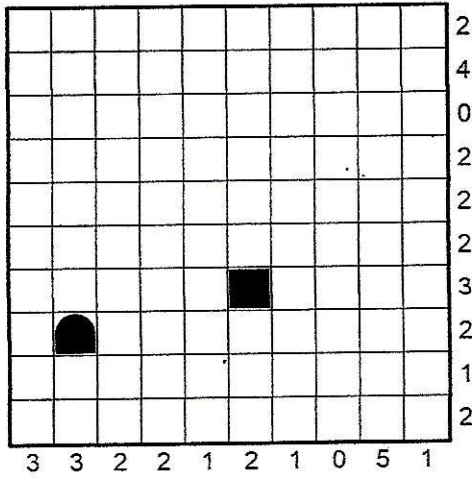

- בדיוק F
- כמעט P
- כלום B

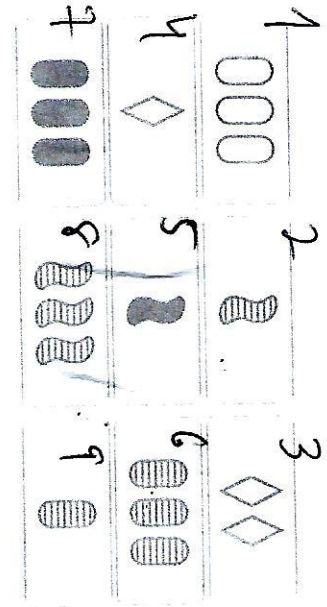
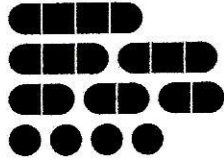

- 852 - P
- 164 - P
- 793 - P
- 519 - FP
- 531 - FF

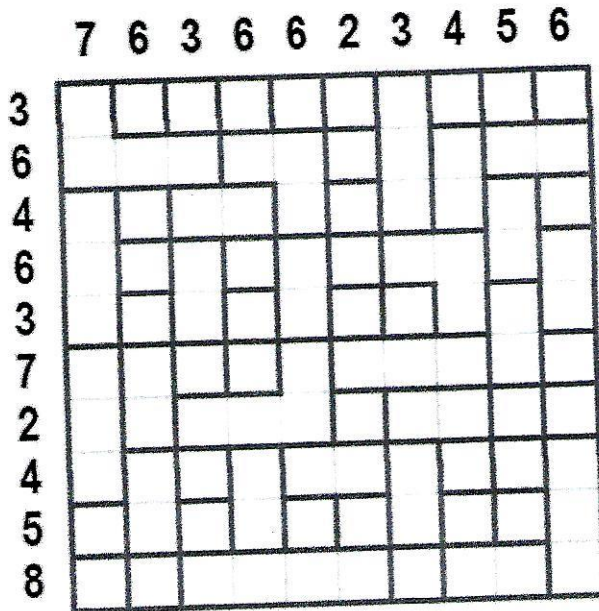

Conceptis
New York Times

2025

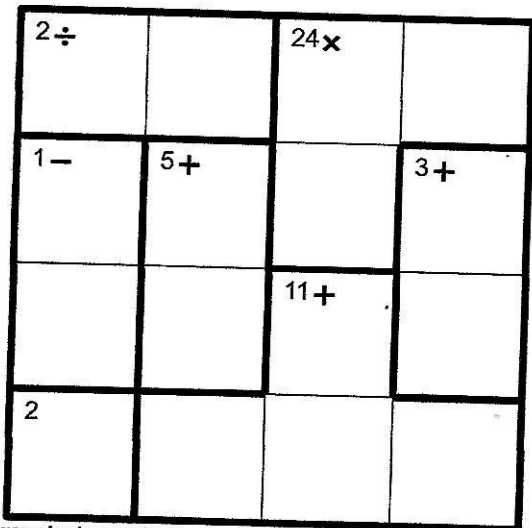

www.kenkenpuzzle.com

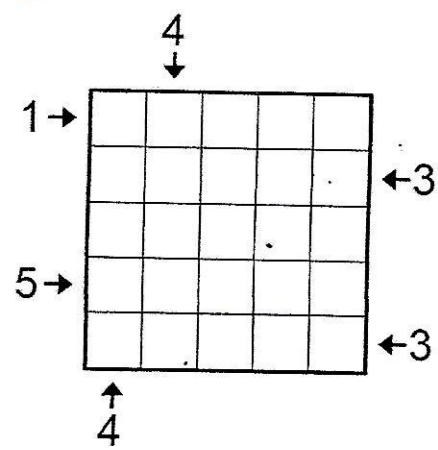

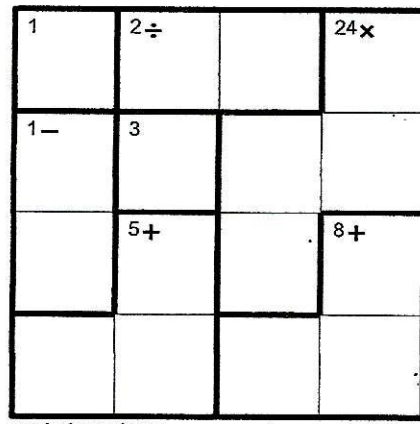
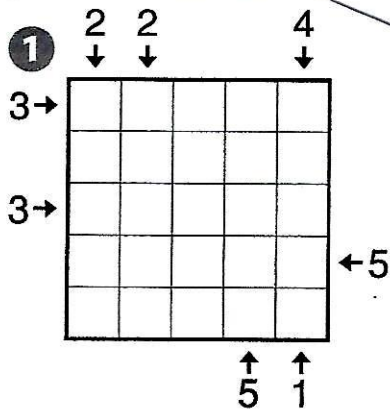

www.kenkenpuzzle.com

3-ENSIGN

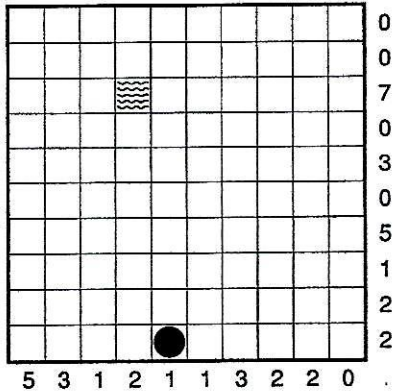

- Battleship: [3 cells]
- Cruisers: [2 cells], [3 cells]
- Destroyers: [2 cells], [2 cells], [2 cells]
- Submarines: [1 cell], [1 cell], [1 cell], [1 cell]

TOUGH NUTS
MISSING DIGITS

Here is a multiplication problem with most of the digits obscured, except in one column. There are no 8's in this problem. Can you deduce the rest of the digits?

$$\begin{array}{r}
 1 _ _ \\
 \times 3 _ _ \\
 \hline
 3 _ _ \\
 _ 6 _ \circ \\
 \hline
 _ _ 7 \circ \circ \\
 \hline
 _ _ _ _ _ _
 \end{array}$$

—J. MARK THOMPSON

אין 8 בכל
התרשים!

274 – PP

123 – F

456 – P

789 – P

167 – F

593 – F

— — —

בדיוק F

כמעט P

כלום B

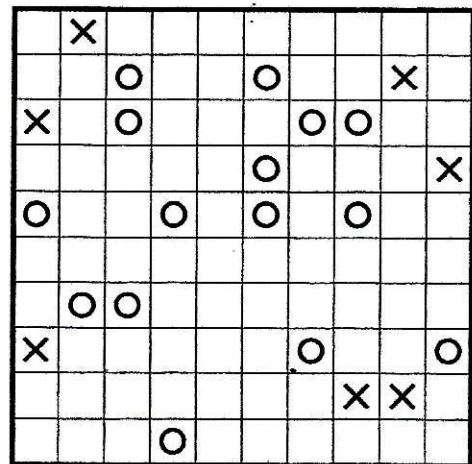
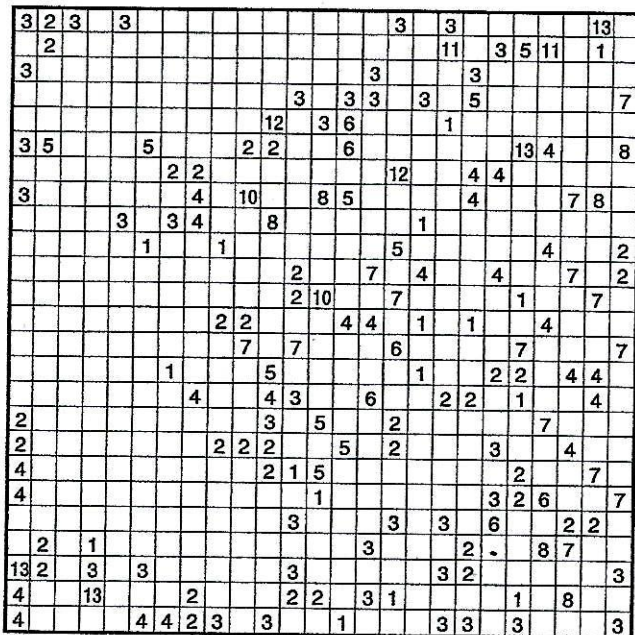

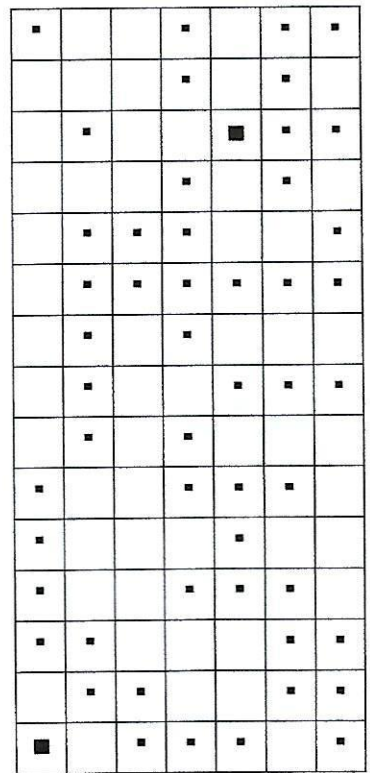
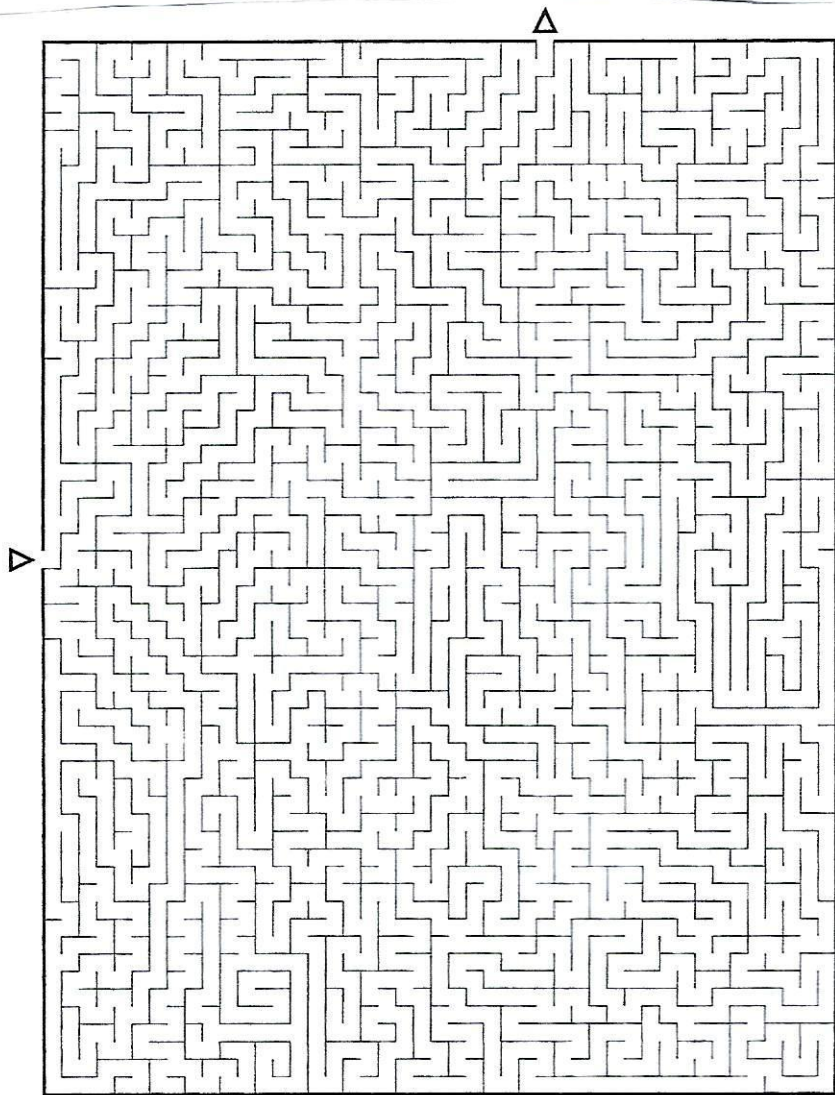

		30		
			1	6
			36	
		18		
24				
		13		

- 987 - P
- 654 - P
- 231 - P
- 863 - FP
- 715 - F
- 804 - F
-
- עוד אחד:
- 123 - F
- 456 - P
- 789 - P
- 175 - P
- 408 - F

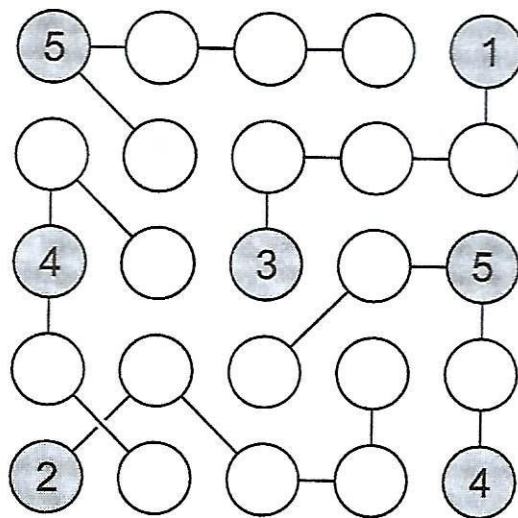

3-		1-	2÷
2	24x		
		2÷	1-
4+			

פבדיוק

כמעט P

26/8a

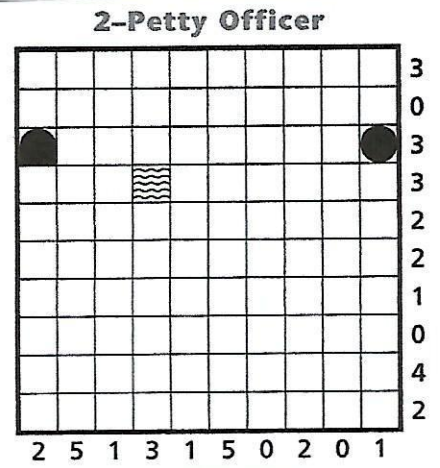
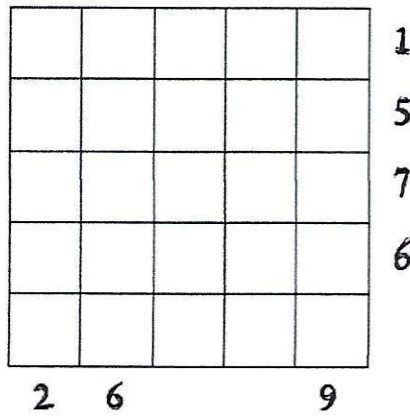
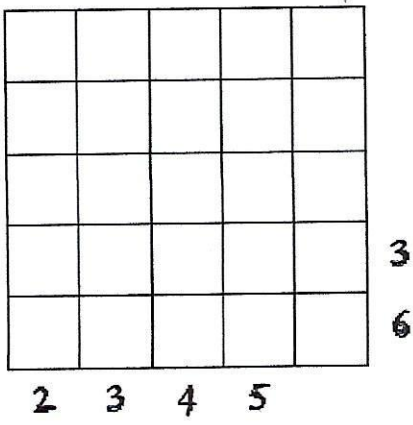

- Battleship
- Cruisers
- Destroyers
- Submarines

1, 2, 3, 4, 5
1, 1, 1, 1, 1
↙

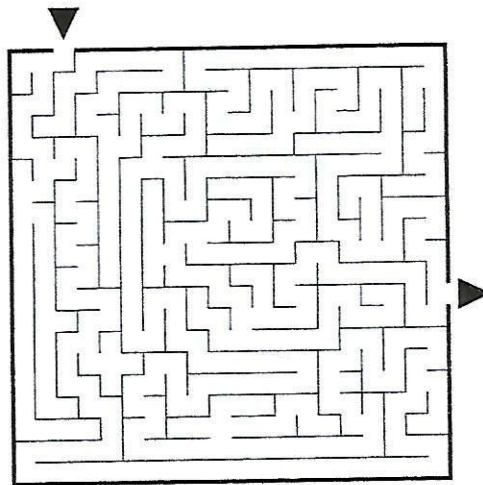
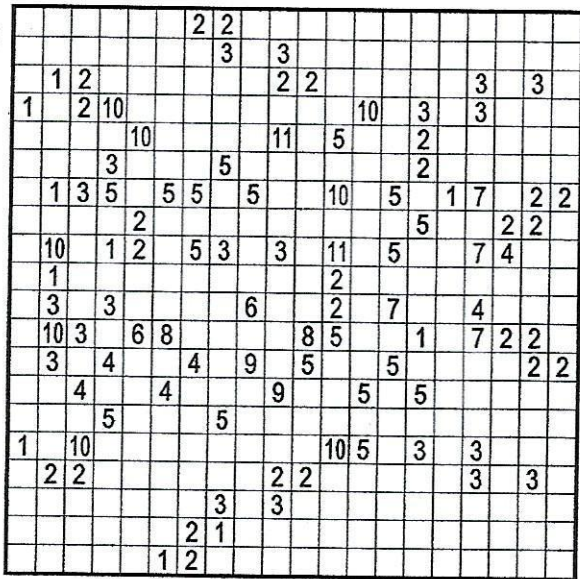
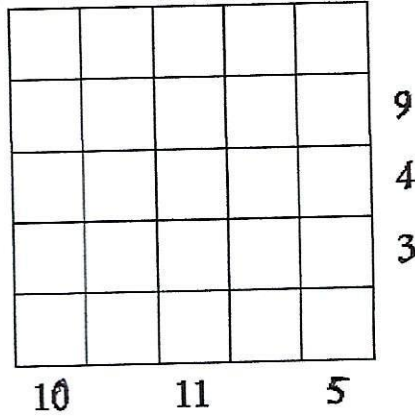
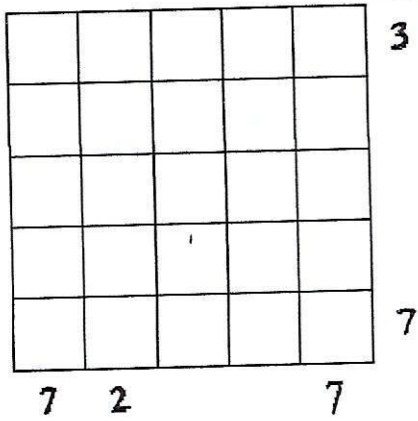

- 1
 - 2
 - 3
 - 4
 - 5
 - 6
 - 7
 - 8
 - 9
- — — — —
— — — — —

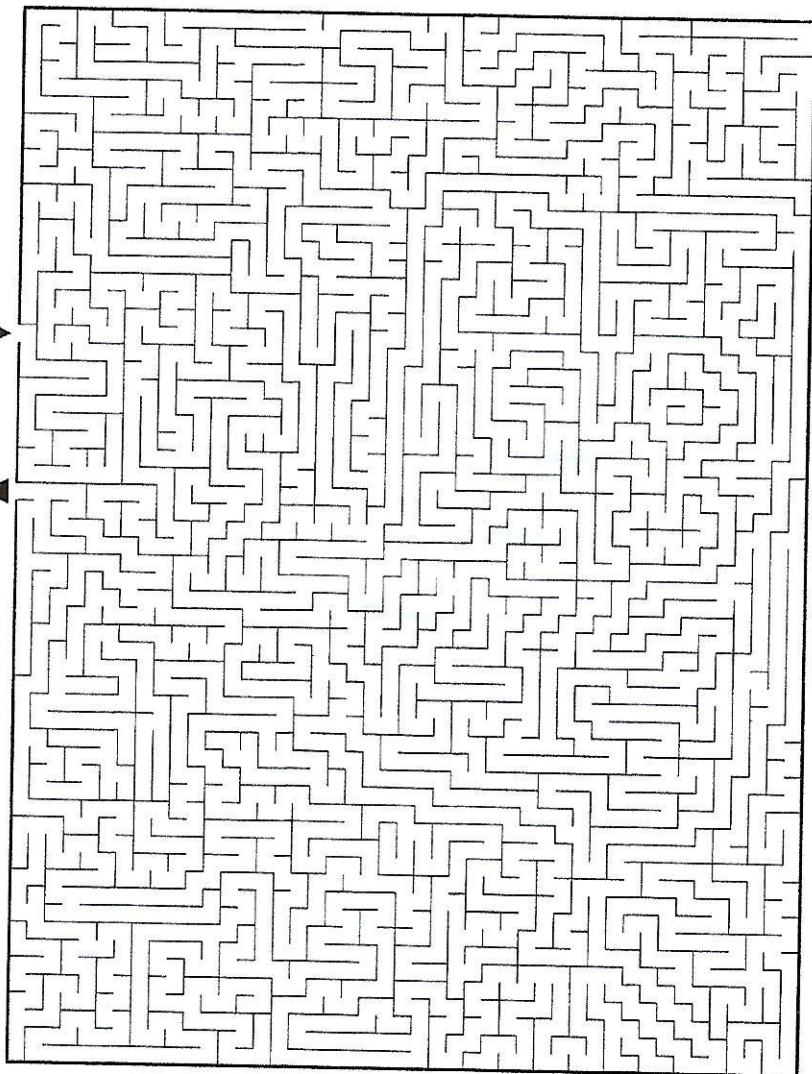

123 - P

456 - B

789 - FP

279 - PP

872 - FP

בדיוק

כמעט

כלום

		30		36	
	12				
6	1			24	
				18	

1-9

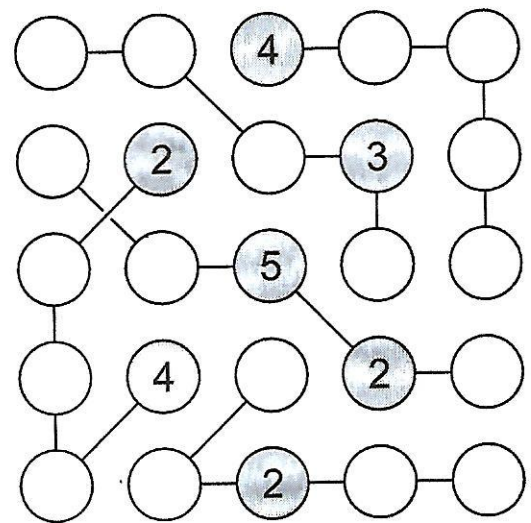
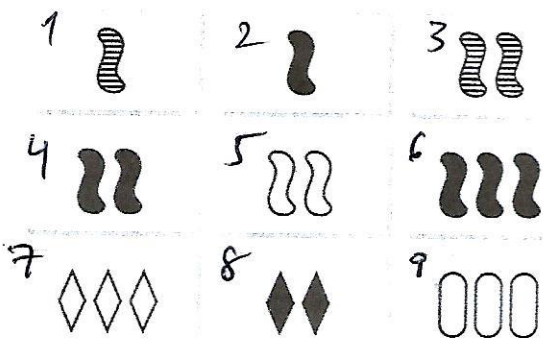
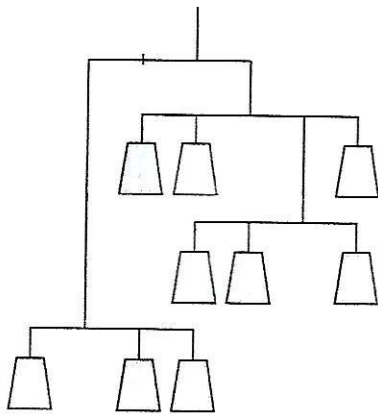

----- 28

5518a

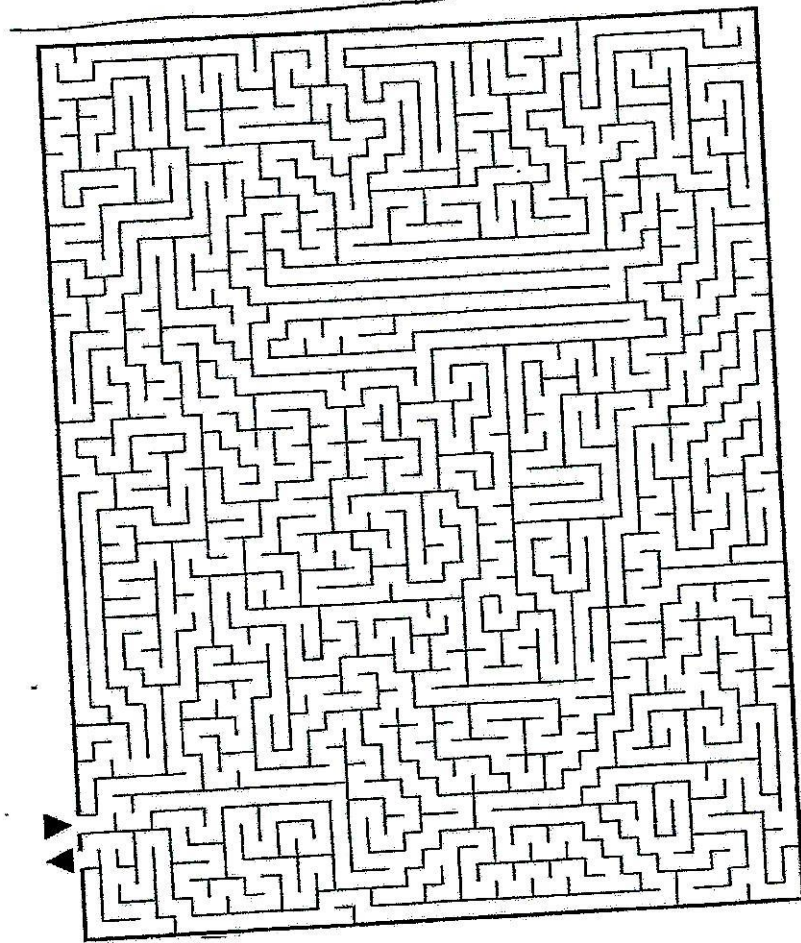

2-PETTY OFFICER

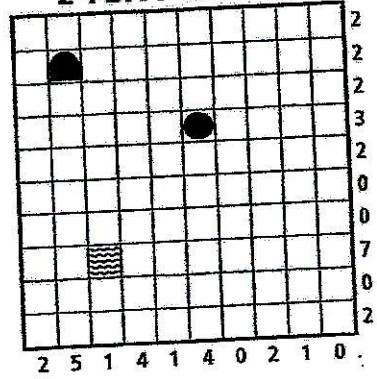

- Battleship
- Cruisers
- Destroyers
- Submarines

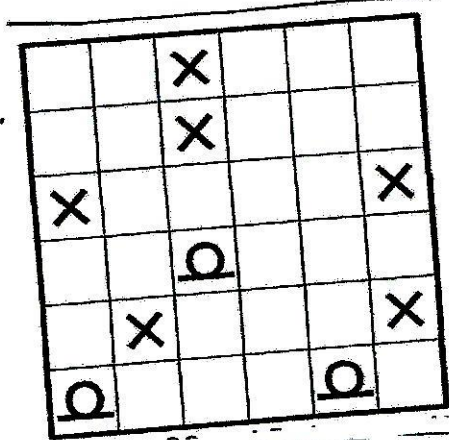

24x			8+
2÷	2		
	3-		24x
2-			

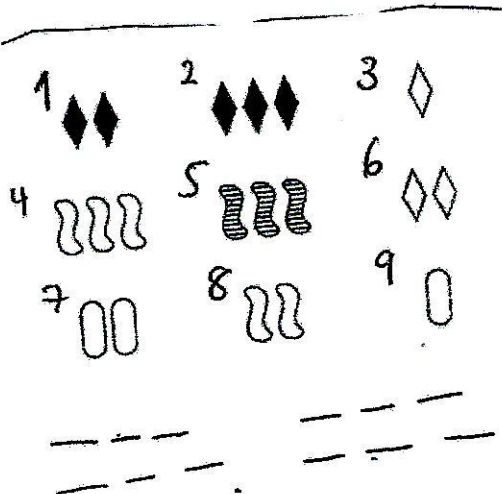
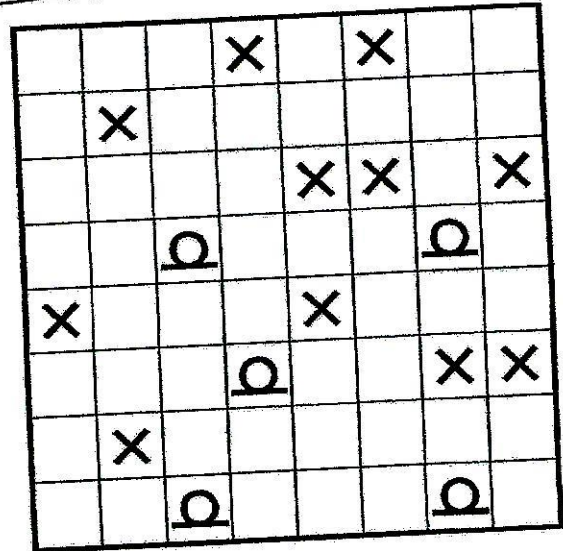

- 278 - B
- 394 - P
- 615 - P
- 951 - P
- 853 - F
-
- 0170B
- 7177AF
- 05727P

10318

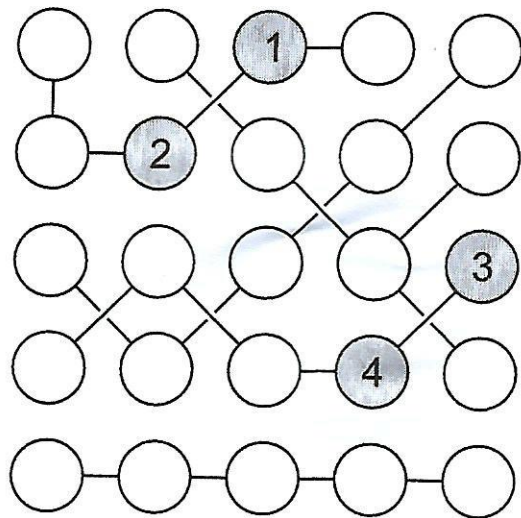
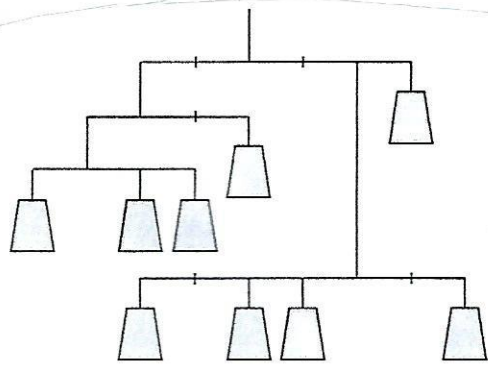
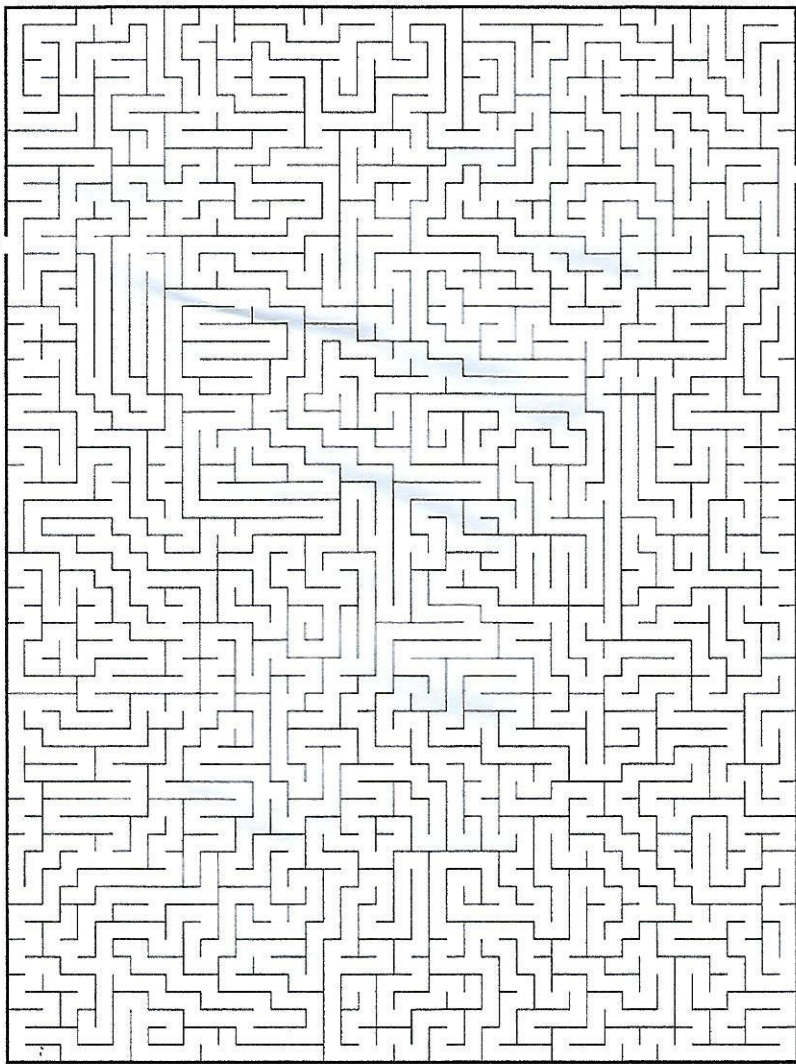

Puzzle 1

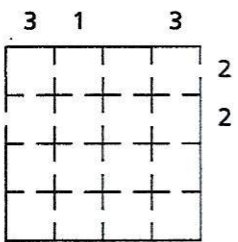

Puzzle 2

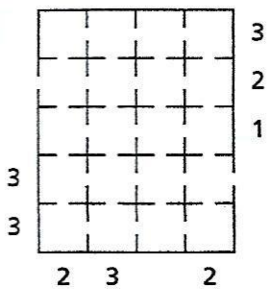

Puzzle 3

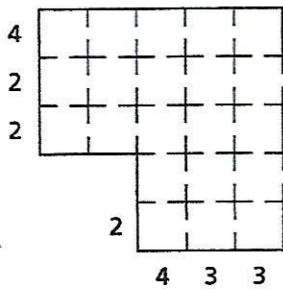

Puzzle 4

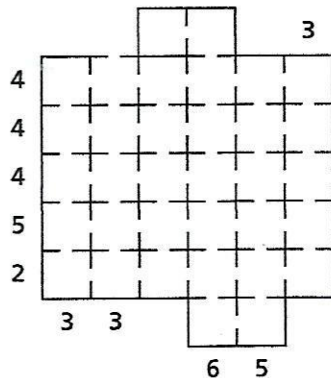

Boily
Puynt
F7017D

357 - B
321 - F
654 - F

987 - F
609 - P
:TRK TIV

569 - P
684 - P
789 - F
456 - PP
123 - B

125/86

5			6		8		2		8					
5	5		4	6	8		9		2	1	8	4	4	
	8								8		8		4	
5	4		4	6		6	9	5	5	5				
				2	2		3			5				
				4		3		4	4	1			4	
9	4			4	6				8				8	
											1			
9	3	3		1	3	1			2	2		9	8	
					6							9	8	
	7	8			3	3	3		2	2		6		
					4	4			6		9			
8					4					5	6	8	6	
6														
	1				1					3	2	5	4	
7					4						2			
7	2	7		1	4	4	1			2	3			
	2								2				4	8
6			1			2	2				3		3	

5				29	36
	1				
	11				
		17		23	

Easy Strimko 008

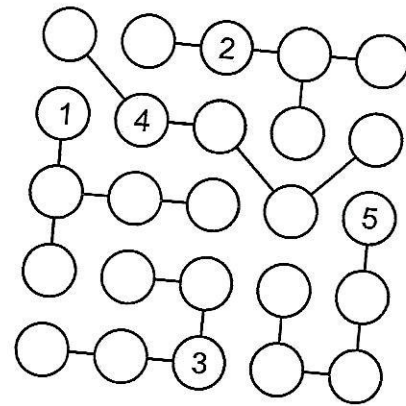
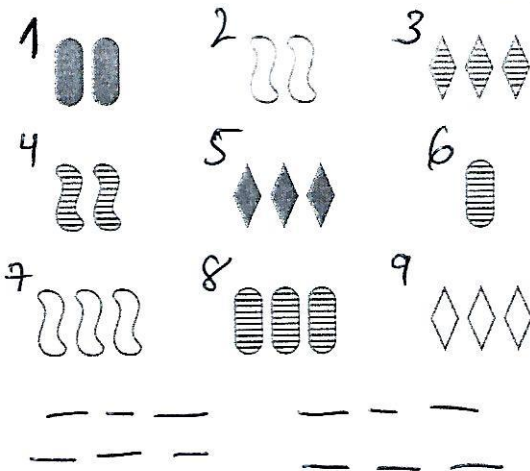

8x		7+	2
3+			1-
	10+	1	
		2÷	

www.kenkenpuzzle.com

5-Commodore

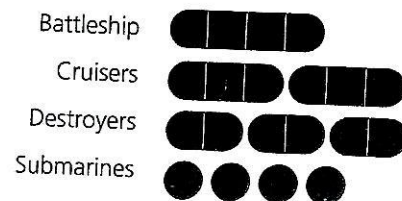
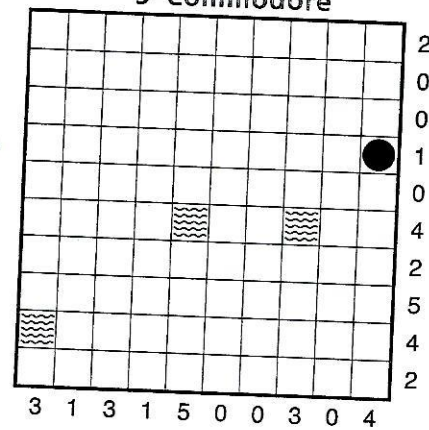

2018a

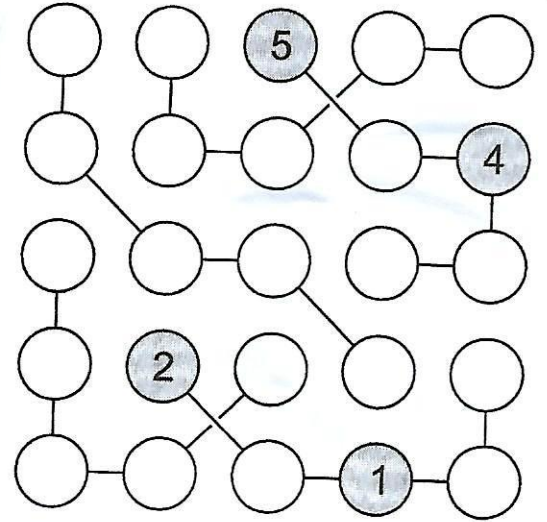
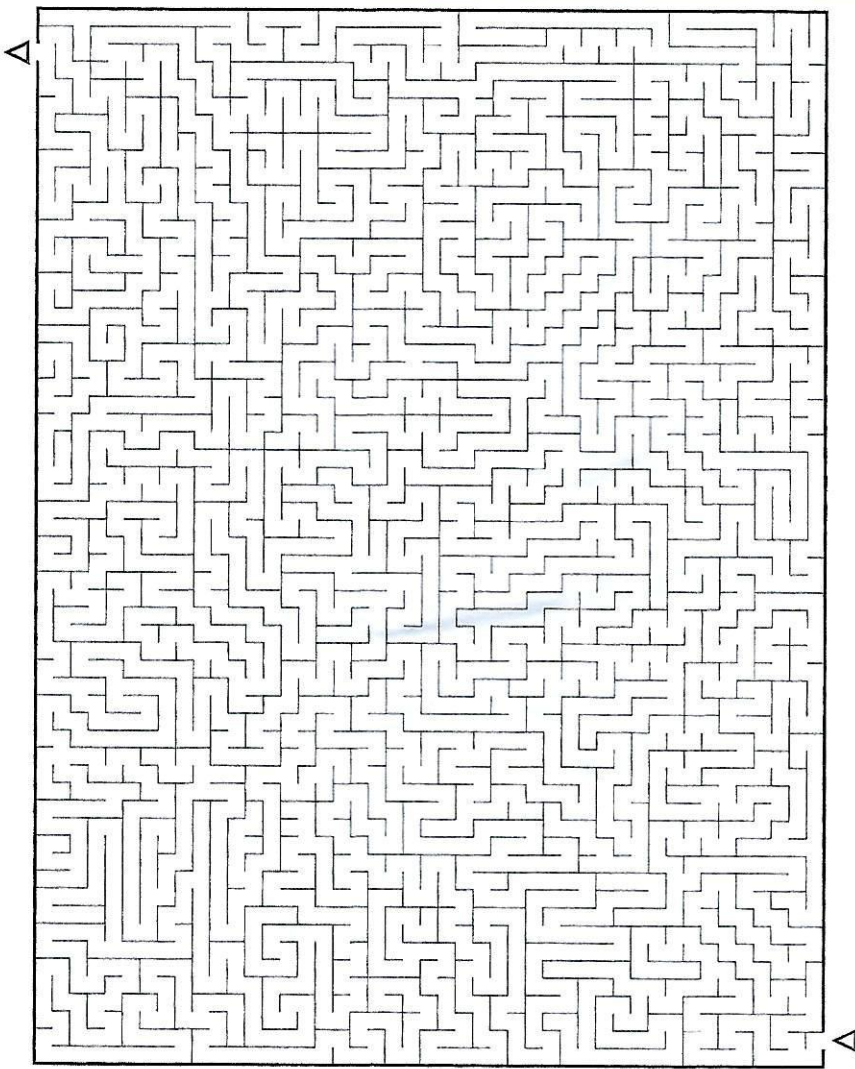

2-Petty Officer

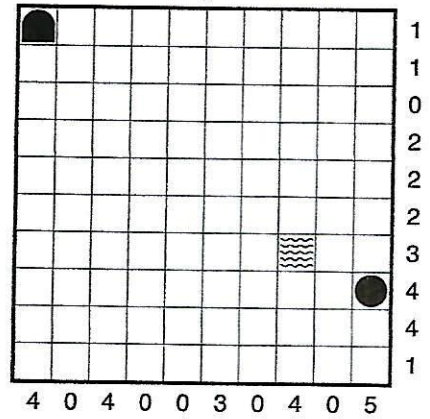

- Battleship
- Cruisers
- Destroyers
- Submarines

			1	
		6		
13				32
		19		
			26	

123- PP
 456 - P
 342 - P
 215 - P

Рубль

ACT 1 #1-6

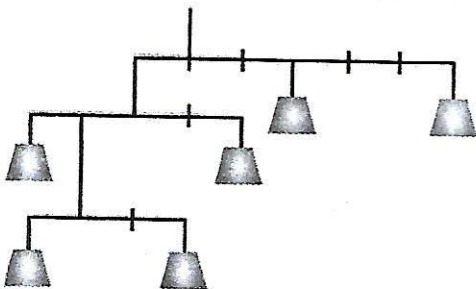

- 1
- 2
- 3
- 4
- 5
- 6
- 7
- 8
- 9

26518a



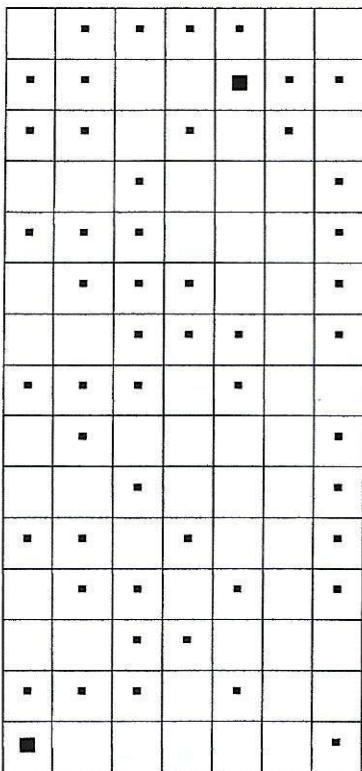
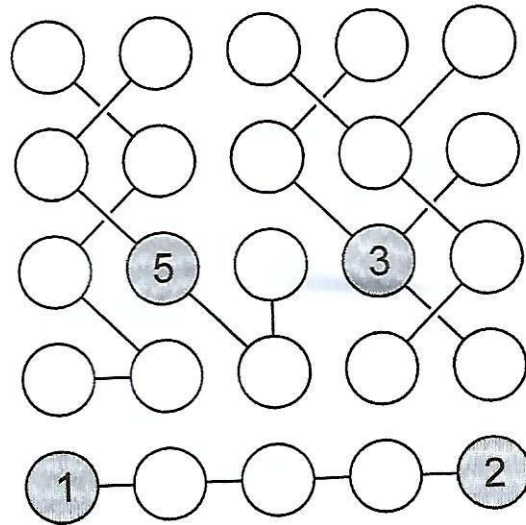
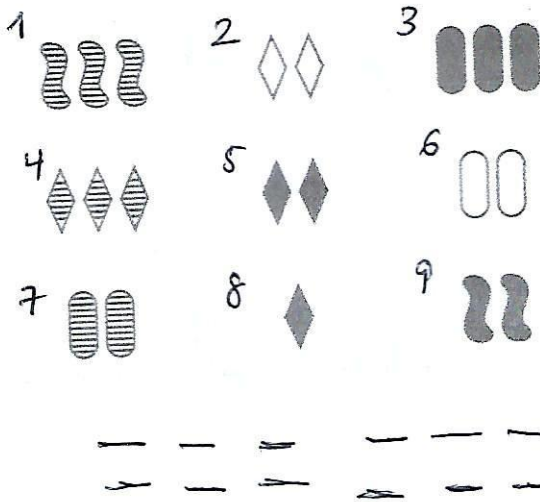
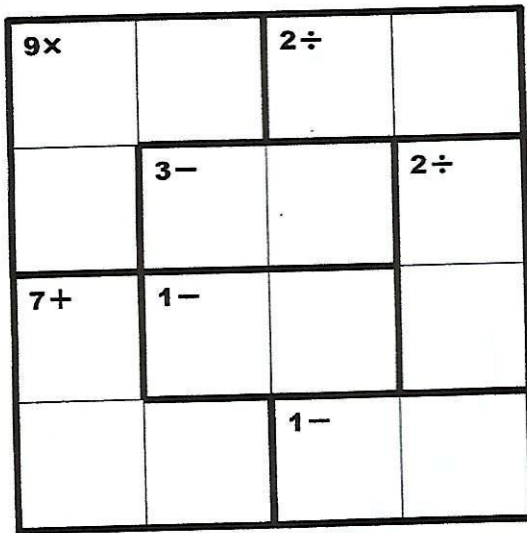
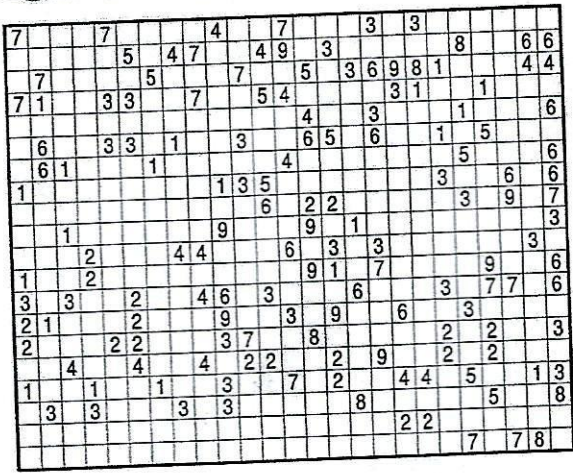

- 123 - B
- 456 - P
- 789 - P
- 690 - PP
- 482 - P

בדיוק
כמעט
כלום

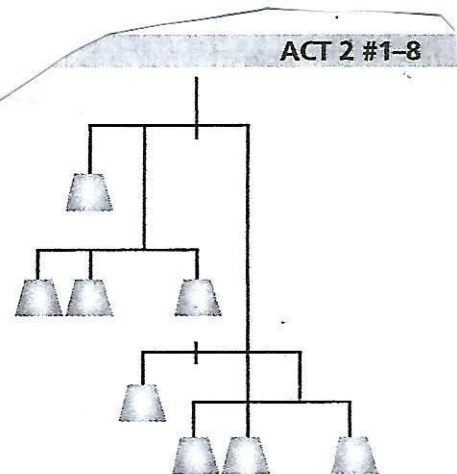

26518b

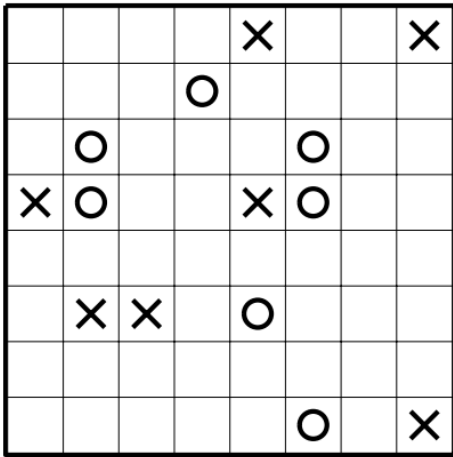

© Conceptis Puzzles 31090104533

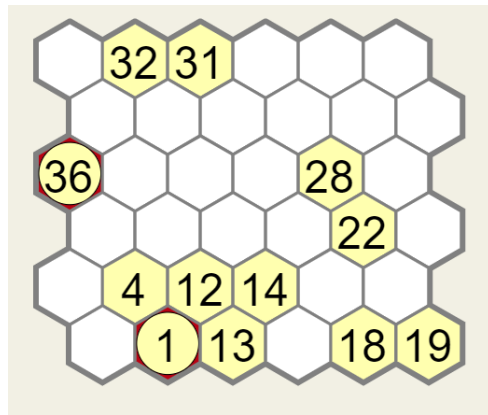
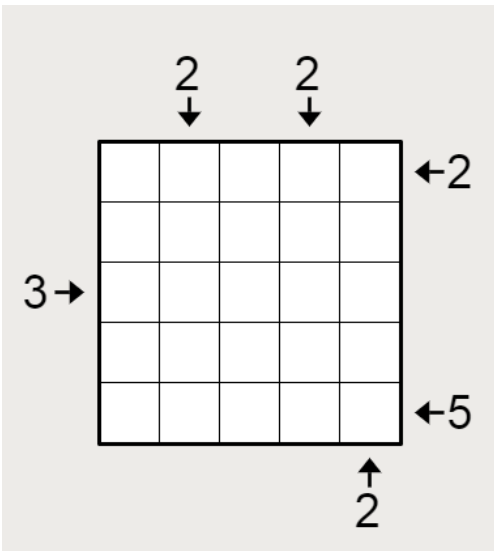
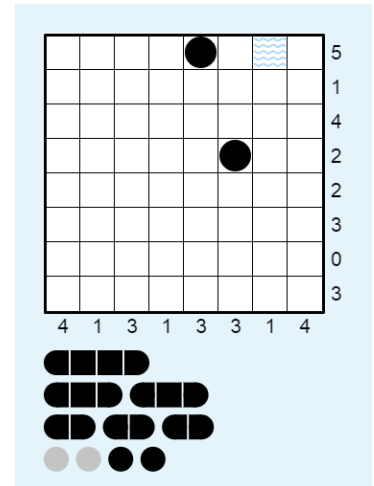
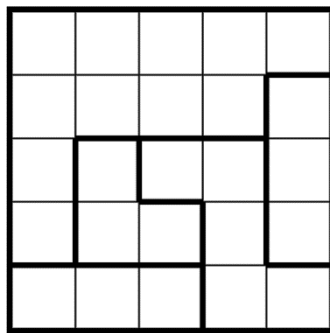
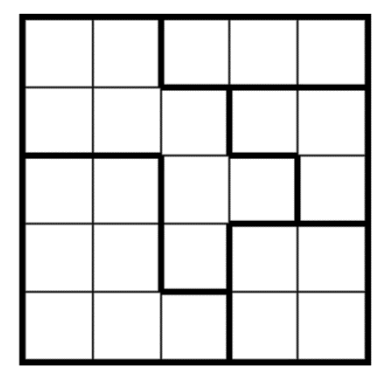
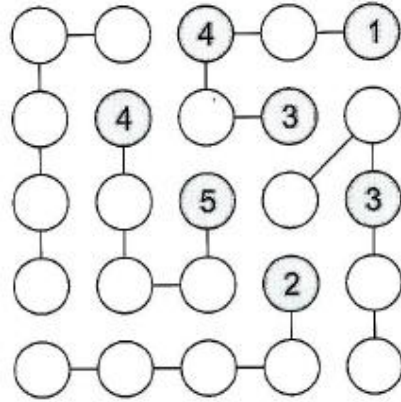

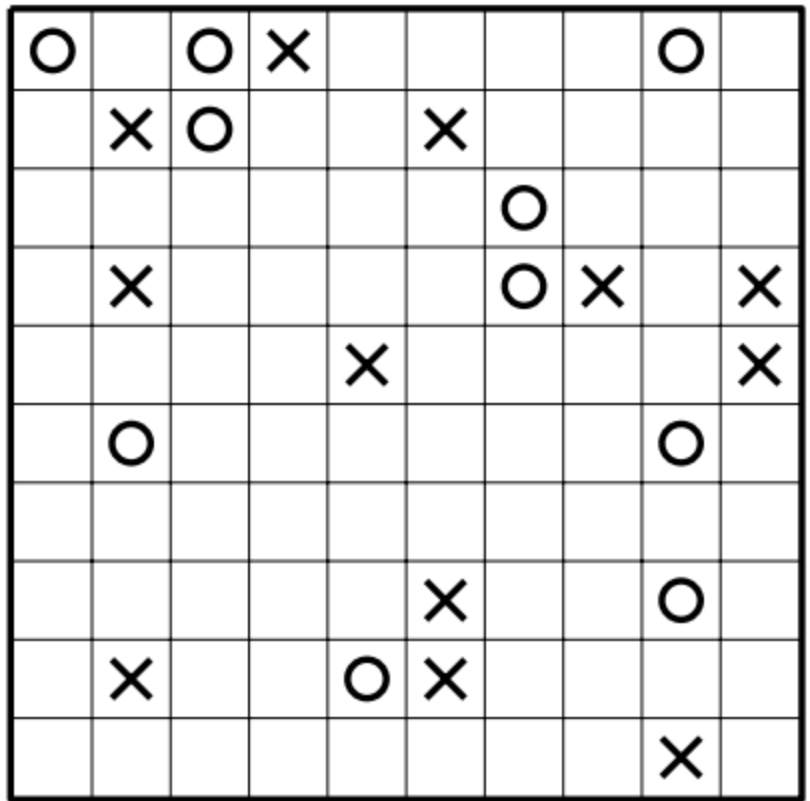
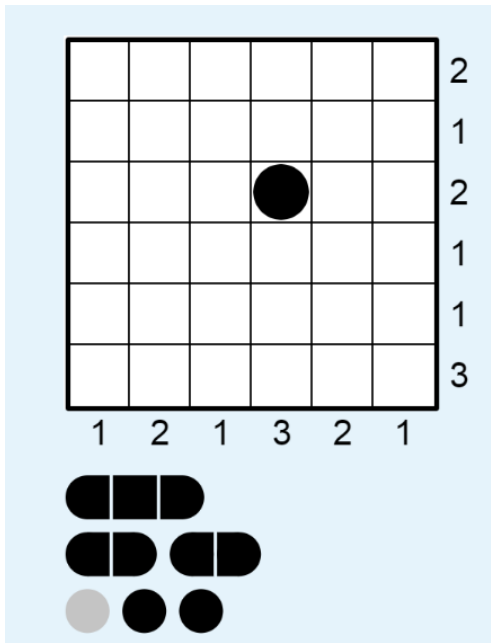

© Conceptis Puzzles 31090104523

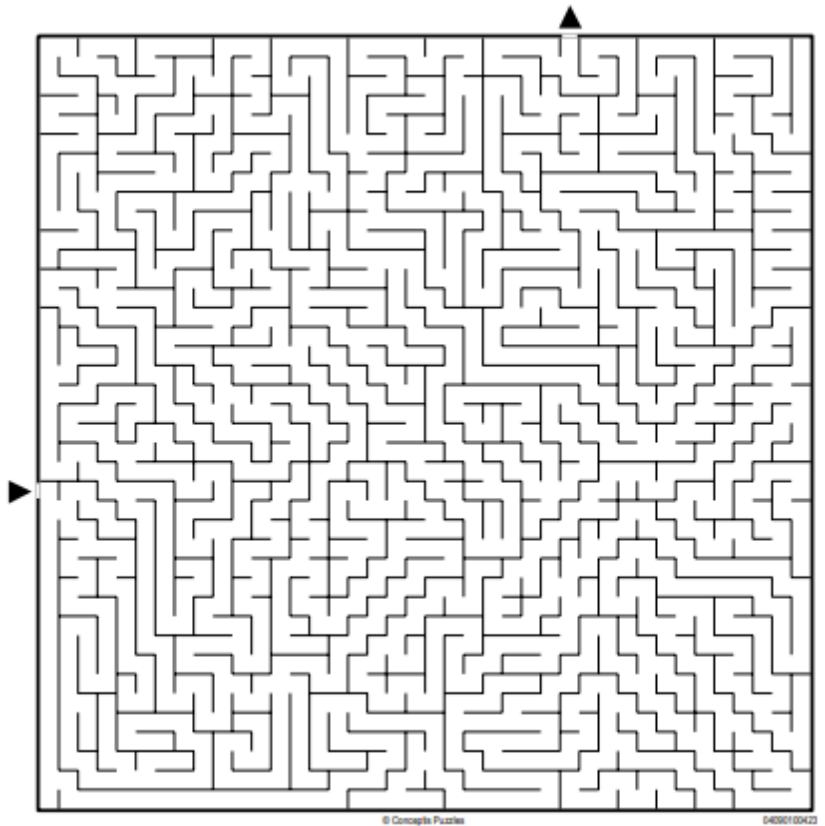
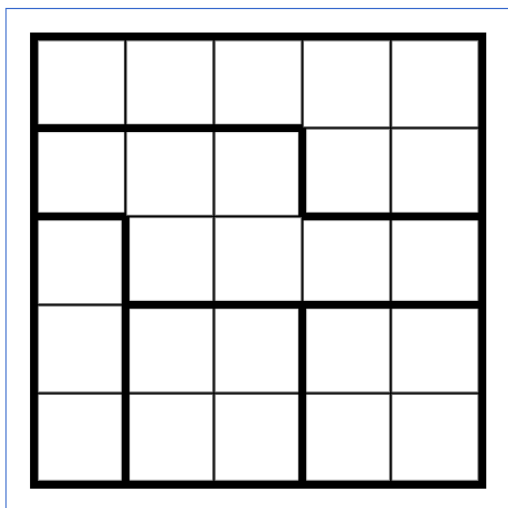
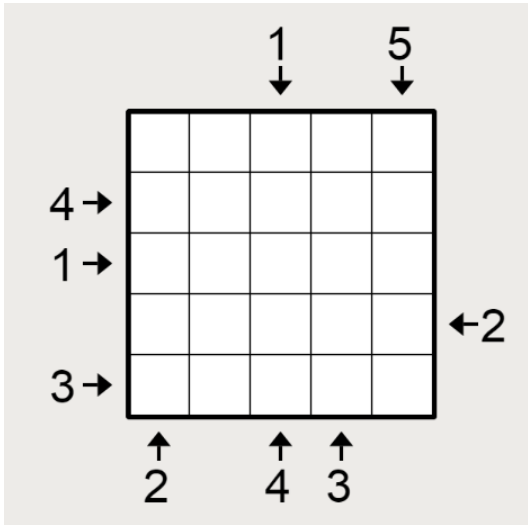

© Conceptis Puzzles 04090100423

593 - P
 278 - P
 146 - P
 924 - B
 851 - PPF

כלום
 כמעט
 בדיוק

2-	24x		
	1-		4
2÷	2	7+	
	3-		

www.kenkenpuzzle.com

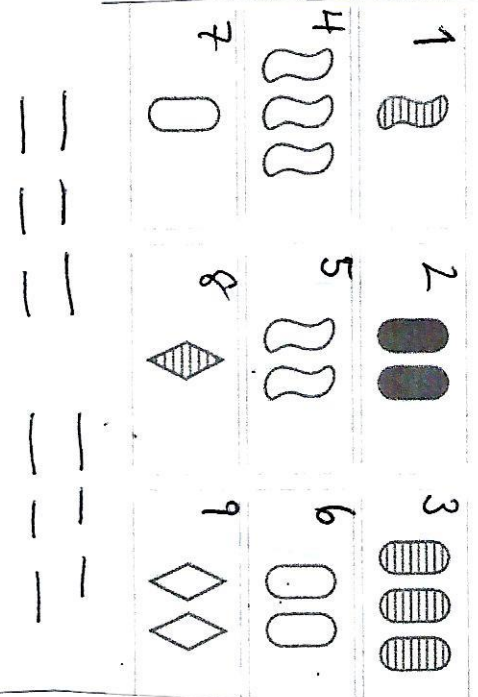

0	1	1	1	1	1	1	1	1	1	0
1	2	2	1	1	1	2	1	2	1	
1	3	3	2	0	2	3	1	1	1	
0	1	1	2	3	2	1	1	2	1	
0	2	3	2	2	1	2	2	3	0	
1	2	1	1	2	1	1	0	3	1	
1	2	3	3	3	1	1	1	3	0	
1	3	1	1	1	3	3	2	3	1	
0	1	0	0	0	1	0	1	1	0	

2-Petty Officer

										3
										0
										2
										4
										2
										1
										6
										1
										1
										0
4	1	3	0	2	0	1	4	1	4	

- Battleship
- Cruisers
- Destroyers
- Submarines

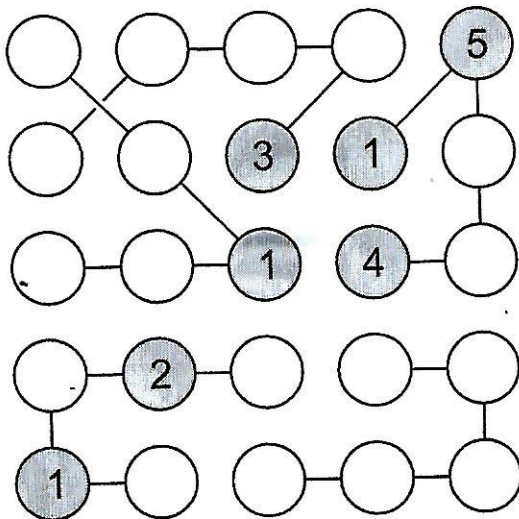

090219

4		2	2		2	2	1	1				7	10	10		5				9				
	5		1		3		3	1	1				10			6	3	5	9	6				
4					1			1	5			2	2	6	3	4	2			6	5			
	5	10	1		1		5	4	4		1	1	4			4								
					1							1				2	2	2	2		5			
	1						5	11		1	1		2	2	10	10	4		4					
8			3	3	2		2	2			1			1			4				10			
	2	2			2	1		3	2	2			1	1			4				1			
			1	2	2			5	3	3	2		1		3	3	3			5				
8						1	3	1			2	2			1		3	3		3	5			
3	1								5	3	2	3		3	3		1	11		2				
							3	3	3			10	10		3	5				3	2			
3						2	2	2		3	3	2	2		5									
10	4					2		1	2	3				2	2	11		1		3				
						1		2	2	2		1	1			1								
												3	3							1	1			
	10	10							1			3	1	3	2	2	2			4				
												1		3	10	2	6			1	4			
									1			3	3	3	1	3	3			2				
												3	10	1		2	2			2	11			
												1			2	2				2				
1															1		2	2		6	2	1		
																1	10			2	2			
11	3					3										5	1	3			1	7		
10																2	2	3	3		5	2	11	
																3	3	5			2	7		
																					2	2	1	4
2	2		3	8		10	11									6	6				3	3	4	

- 123 – PP
- 456 – B
- 789 – F
- 732 – P
- 208 – F

פבדיוק
 פכמעט
 פכלום

3	3		9	5		6			6	8		9	7	7			
				5						2	2						
		3	6	6		4			9		8	3					
9	9		3		1		7	4		4	3	3		3	6		
			7			9			4	3	3	4		2	9		
9		4			4					4	2	2			6		
11	2	2			4		6	3		3	3		3	3			
1		3		3	6	4			4	4				8		2	
		1		3				3	2	8	4		4			1	2
		3		3					2						3	5	
		1		5			4		4	7	2	10	3	3	3		5
3	11		3	1		5		4		4	2			10	6	12	2
		4		1		3	5	5		4	3	3					2
3		3				5	3	7		4		12			6		
		1			3		3	4	8			2					7
		4	1		2	2		5	3	3		2			7		4
2								4			1				2	2	
2	2								4	6			1			1	
2	2	2							4				8				4
		2	2	2				6			8	2	3	3			
8			2	5			5				1	2			8	3	3
		5															
			1			3	7				3	3			3	3	
5		7				3				4	4	8	6		4	4	
8	7		1	9			9		7			8		6	3	3	

Maze #79

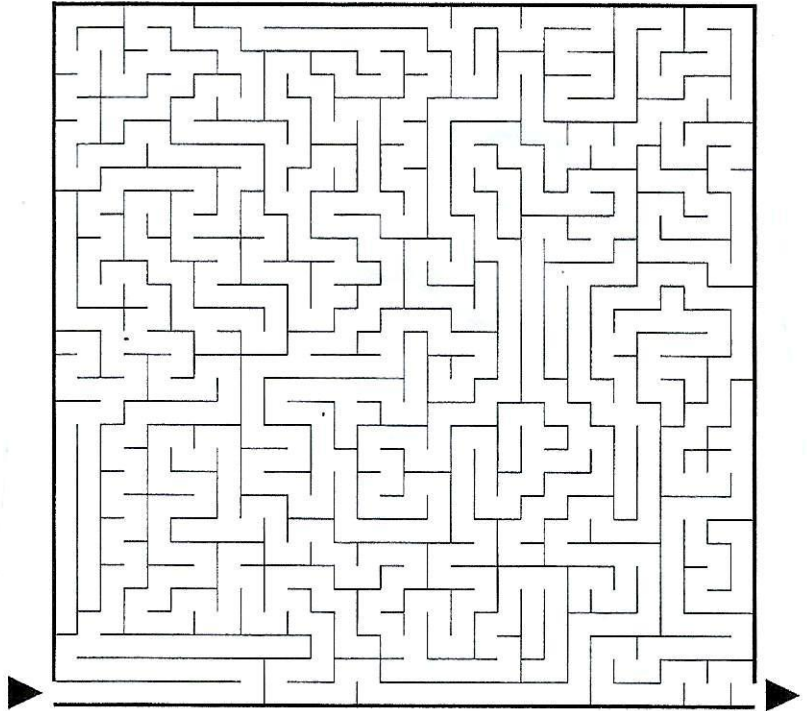
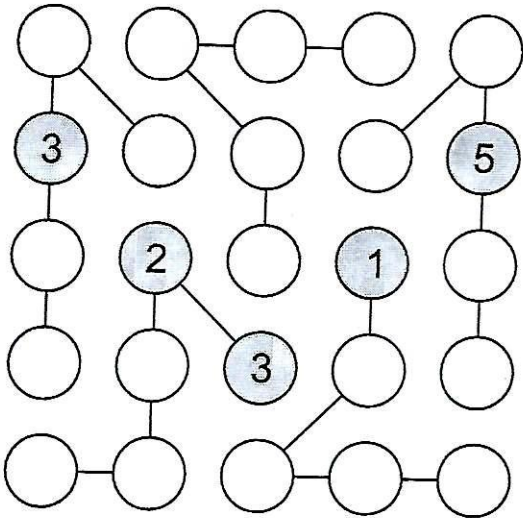

3-Ensign

																				2
																				2
																				2
																				0
																				1
																				6
																				2
																				3
																				1
																				1
2	1	6	0	2	1	2	1	3	2											

- Battleship
- Cruisers
- Destroyers
- Submarines

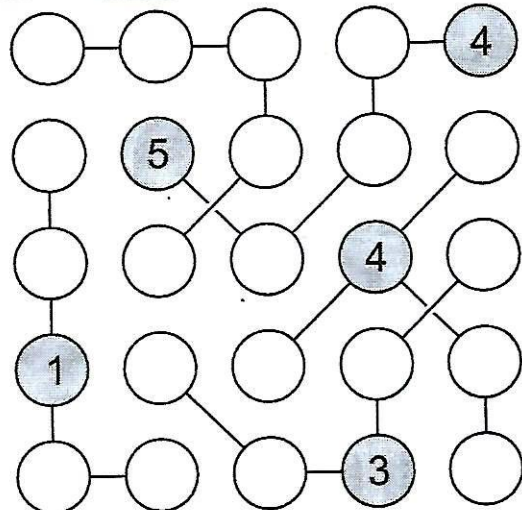

Maze #78

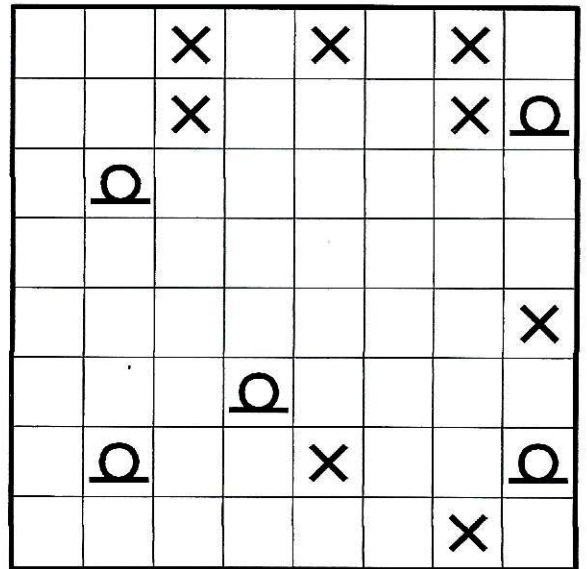
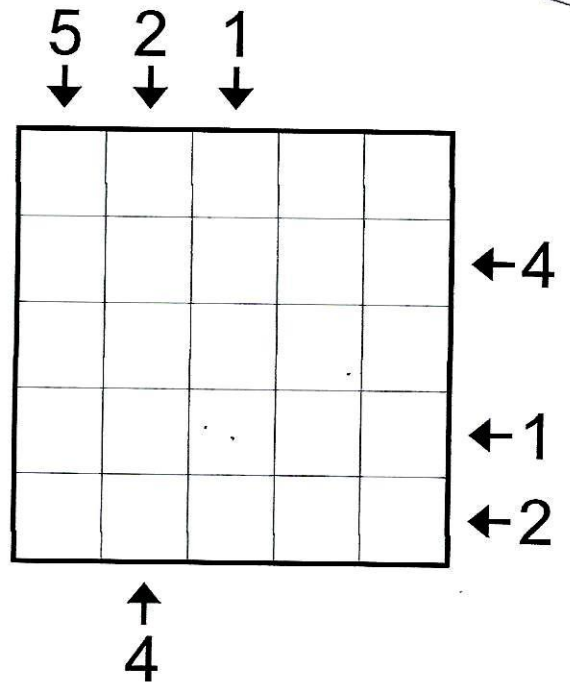
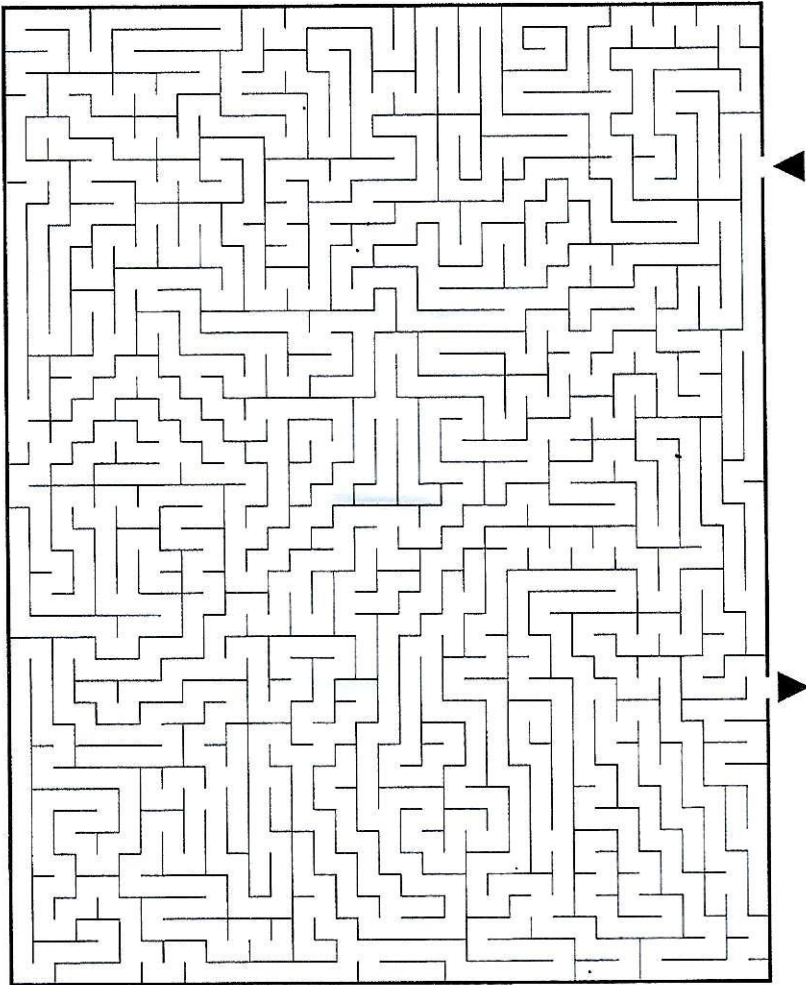

© Conceptis Puzzles 31090103082

1-	12x	2÷	
		6+	4
3-	2÷		
		1-	

www.kenkenpuzzle.com

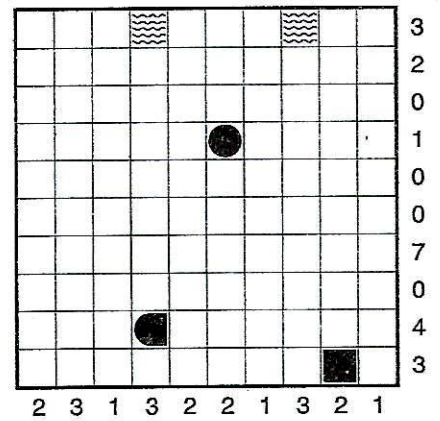

- Battleship
- Cruisers
- Destroyers
- Submarines

1913

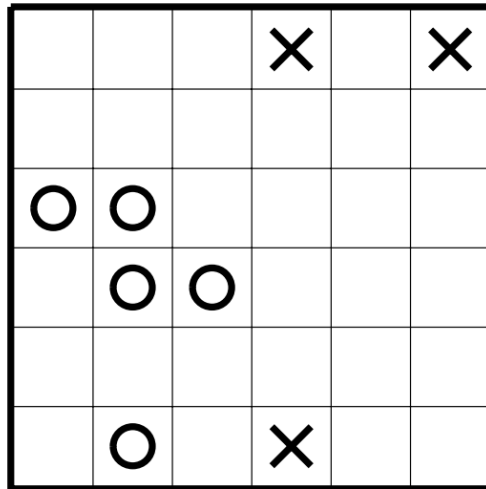
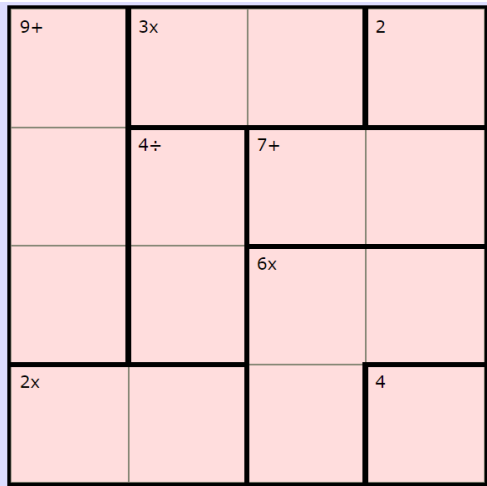

© Conceptis Puzzles 31090104932

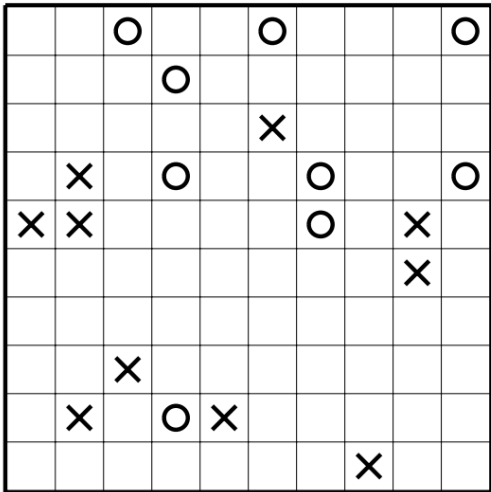

© Conceptis Puzzles 31090101387

1-SEAMAN

3 1 2 1 0 3 1 3 0 6

1
3
6
2
1
0
1
3
2
1

BATTLESHIP

CRUISERS

DESTROYERS

SUBMARINES

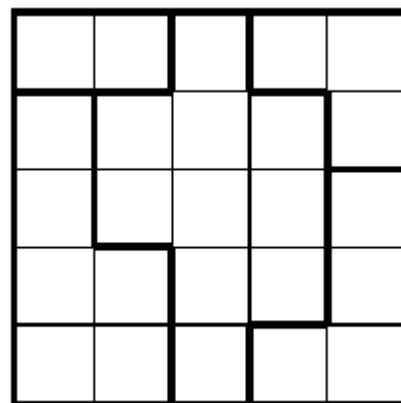
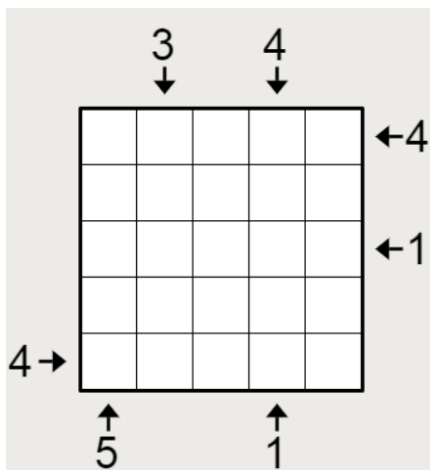

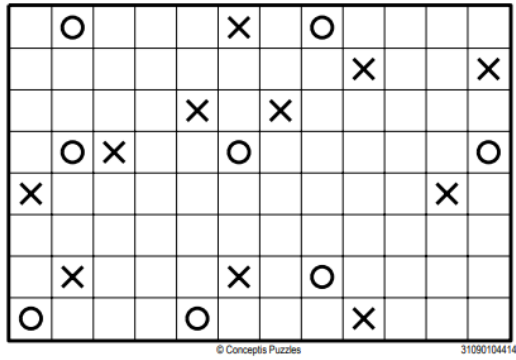
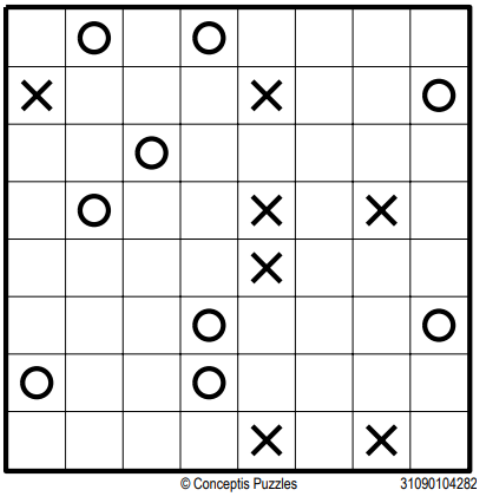

© Conceptis Puzzles 31090104282

© Conceptis Puzzles 31090104414



יש שלוש שלישיות של שלוש ספרות. השתמשו בשבע ספרות שונות כדי שמכפלות השלישיות יהיו שוות.

מצאו את המספר הקטן ביותר שיש לו 36 מחלקים.

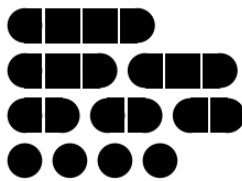
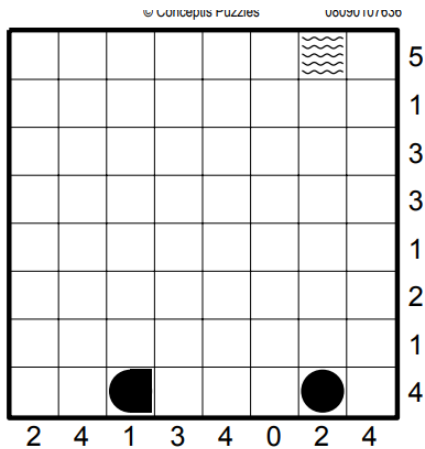
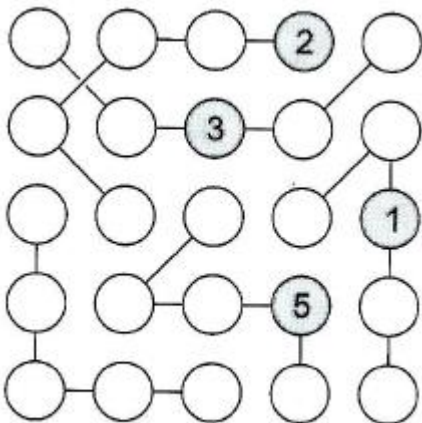
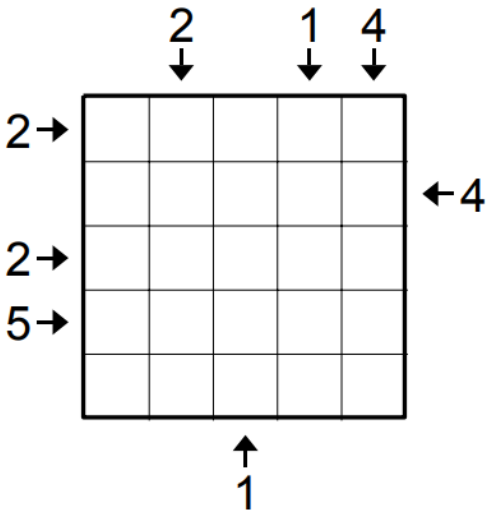

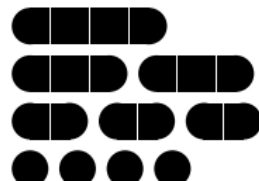
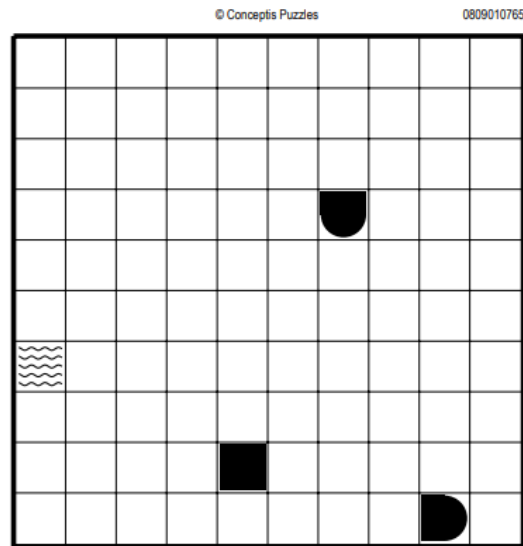
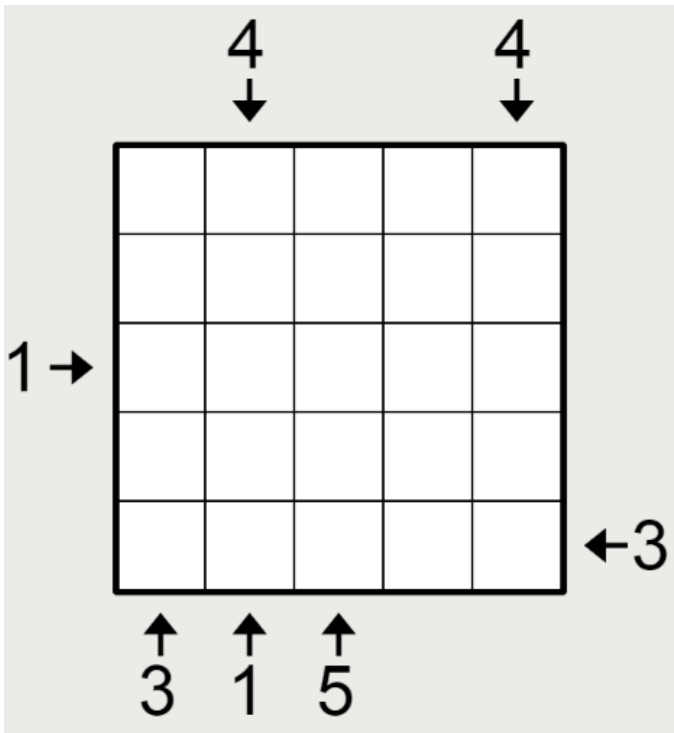
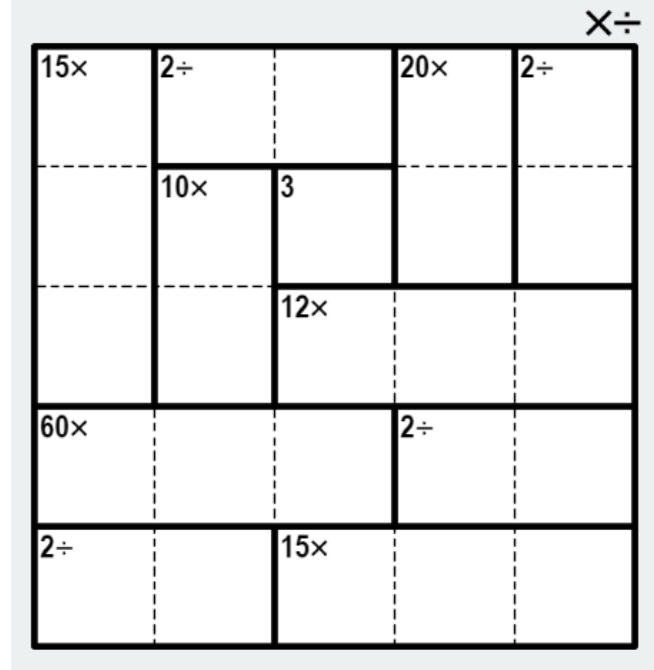
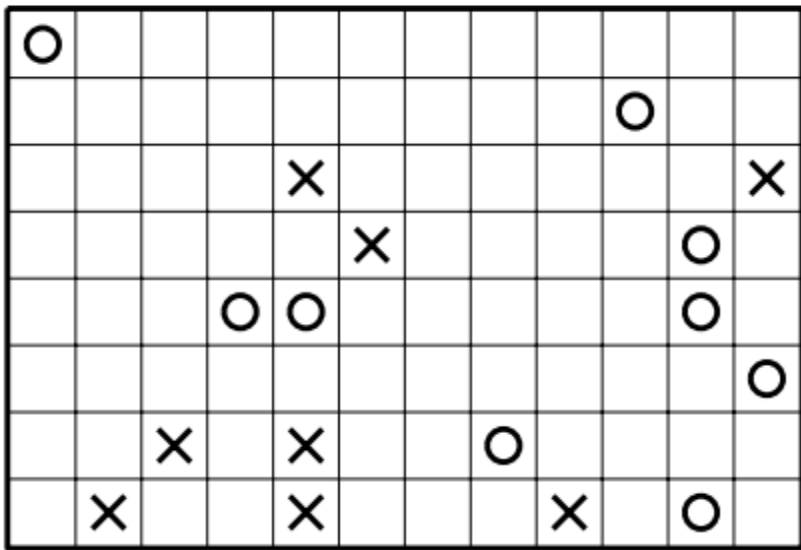

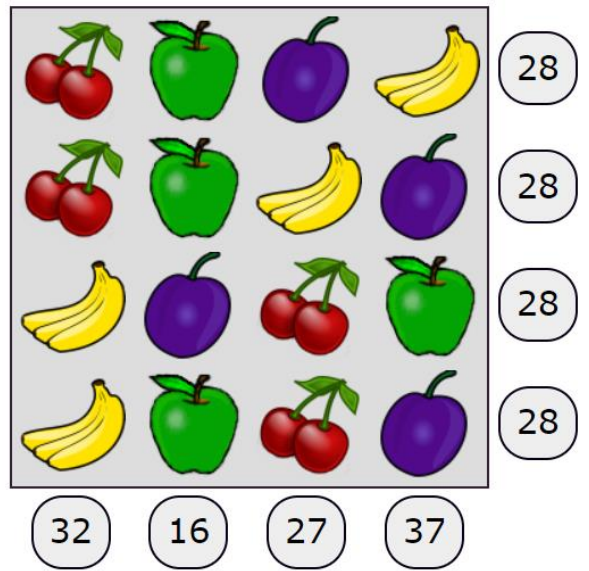
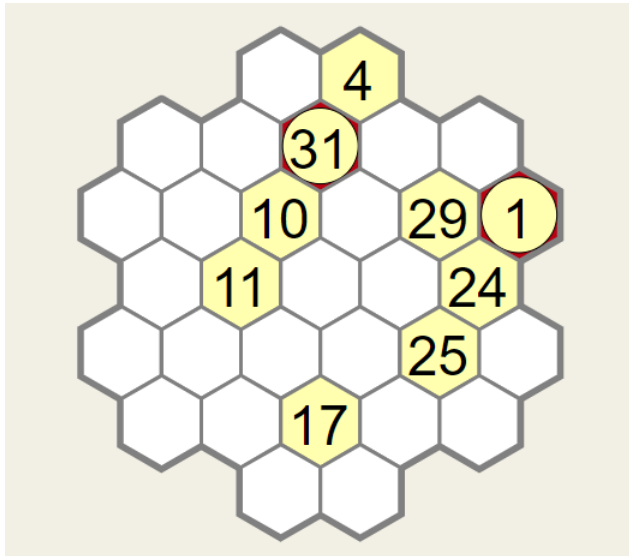
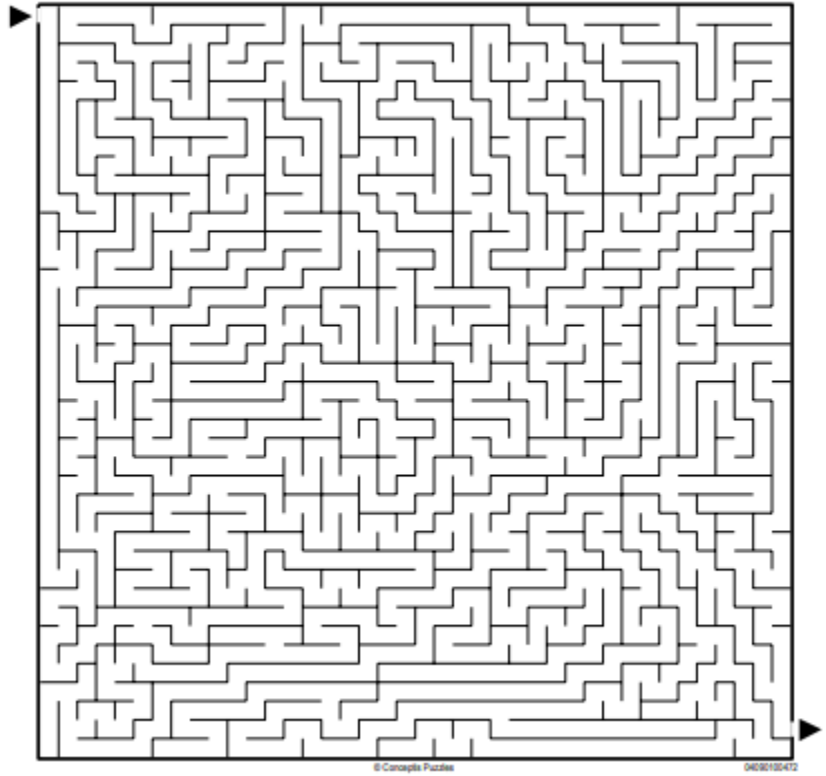

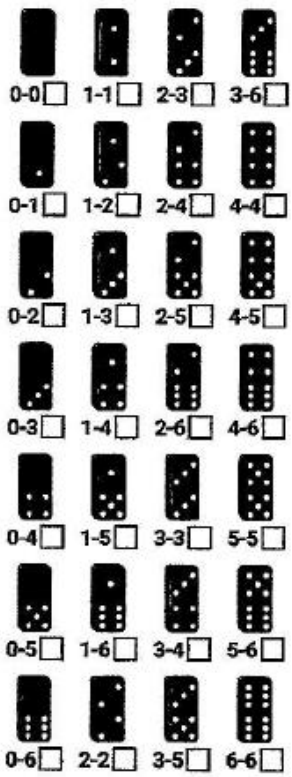

0 0 0 0 2 3 6
 0 2 2 3 5 6 6
 0 0 1 2 2 3 4
 7 3 4 4 4 6 6
 0 1 1 2 4 5 5
 2 3 5 5 5 6 6
 1 1 1 2 3 3 4
 1 3 4 4 5 6 6

00 01 01 01 02 12 02
 15 34 13 22 36 34 45

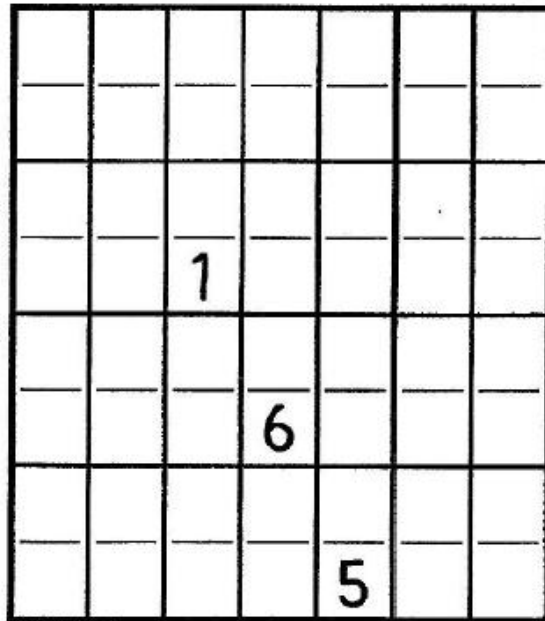

12 25 73 05 34 23 34
 45 66 45 66 66 45 66

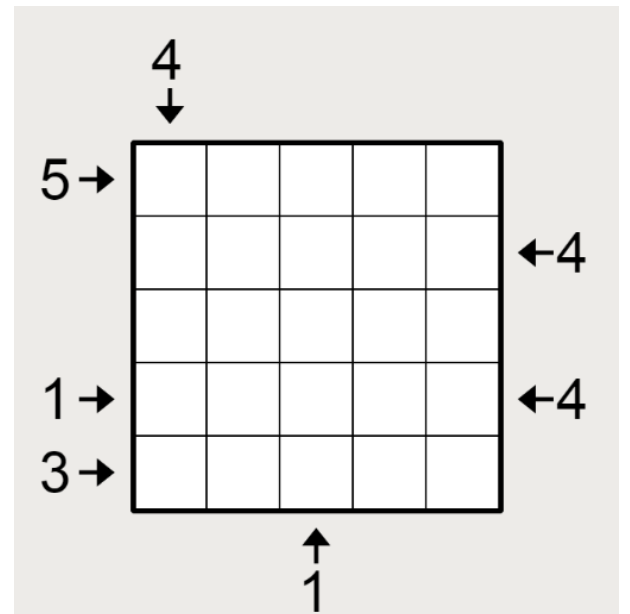
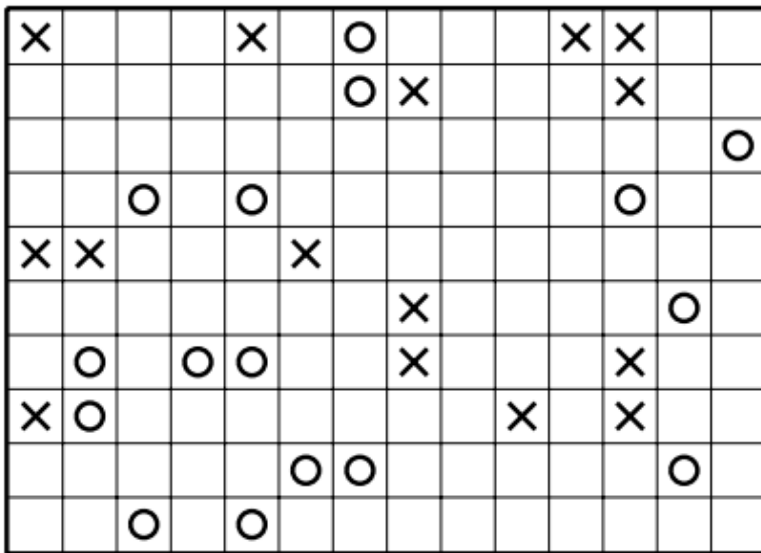

3-ENSIGN

